



PC1200i Crimper
with CrimplQ™ Controller
Operator Manual



Table of Contents

PC1200i Safety Precautions	4
PC1200i Initial Crimper Setup	5
High-Level CrimplIQ™ Controller Capabilities	6
CrimplIQ™ supports the following features.....	6
PC1200i Series	7
PC1200i Features	8
Initial Crimper Setup	9
Overview.....	9
Crimper Operations	10
Logging In.....	10
Default User Accounts.....	10
Navigating the CrimplIQ™ Controller	11
Basic Application Guide.....	11
Top Menu.....	11
Left Slide-Out Menu Functions.....	12
Left Slide-Out Menu Information.....	12
Using the Main Menu	13
CrimplIQ™ controller Main Menu Screen Options.....	13
Crimper Operations	14
Main Crimper Operations Screen.....	14
Load Crimp Specifications.....	14
MyCrimp® - Search Screen.....	15
Key Functions of MyCrimp®.....	15
MyCrimp® - Results Screen.....	16
MyCrimp® - Crimp This Specification.....	17
Managing Crimp Specifications.....	17
Crimp Specifications with Special Handling Requirements.....	18
Favoriting Crimp Specifications	19
Editing a Favorite.....	20
Favorite Special Handling.....	20
Crimp to Diameter	21
MyCrimp® Industrial	22
Entering Industrial Measurements.....	22
Beginning a Crimp	24
Loading Dies.....	24
Selecting a Die.....	25
Change Die Mode.....	26
Crimp Operations	27
Performing the First Crimp.....	27
Measuring a Crimp.....	28
Crimp Operations Screen.....	29
Crimp Operations Screen Sections.....	29
Operational Information.....	30
Crimp Detail Panel.....	30
Crimp Mode.....	32
Crimp Information.....	33
Crimp Management Function Buttons.....	34

Table of Contents

Settings and Support	35
Machine Configuration.....	36
Machine Configuration Options.....	36
Managing Preset Dies.....	37
Managing Users.....	38
Self Calibration Mode.....	38
Default User Accounts.....	38
Maintenance Mode.....	39
Setting Up an Internet Connection.....	39
Using an Ethernet Connection.....	39
Using a Wi-Fi Connection.....	40
Connecting to a Captive Portal.....	40
Verifying Connection Status.....	40
Testing Proper Connectivity.....	41
Additional Connection Options.....	41
Internet Access Requirements.....	41
Backup to CrimpCloud®.....	42
General Configuration.....	42
Support	45
Create a Ticket.....	46
What Happens Next?.....	46
Conti Fluid Solutions.....	47
Training Manuals.....	47
Machine Information.....	47
Other Topics	48
Integrated Caliper Measurements.....	48
Configuring CrimpIQ™ Calipers (Bluetooth).....	48
Configuring CrimpIQ™ Calipers (USB).....	48
Setting Up USB Calipers.....	48
Using CrimpIQ™ Calipers.....	49
Connecting Bluetooth Calipers	50
Initial Setup.....	50
Access the device's Bluetooth Settings.....	51
Find the Bluetooth Accessory in the list of all available devices.....	52
Test Using the Caliper.....	53
Troubleshooting: Number Pad Not Showing.....	53
Additional Notes about the Bluetooth Caliper Accessory.....	53
PC1200i Die Part Identification	54
PC1200i Die Installation and Management	55
Adapter Die Installation.....	55
Hydraulic Die Installation.....	56
PC1200i Lubrication Procedure	57
PC1200i PLC Reset Procedure	58
Resetting the PLC to Its Original Settings.....	58
PC1200i Troubleshooting	59
PC1200i Warranty	60
CustomCrimp® “No Nonsense” Warranty.....	60

SAFETY PRECAUTIONS



- Read instructions and identify all component parts before using the crimper.
- PC1200i crimper can produce 830 tons of crimping force.
- Keep both hands away from pinch points.
- Consult the Continental Crimp Specifications Manual for correct crimper setting and crimp measurements.
- Always wear eye protection.

PC1200i Initial Crimper Setup

Hydraulic Oil Check: Check the hydraulic oil level in the sight glass window on the rear of the reservoir.

Notes:

- The reservoir requires 80 gallons of ISO grade 46 hydraulic oil for complete fill.
- If necessary, oil can be drained from the port at the rear bottom of the reservoir.



Connecting Crimper's hoses to the Power Unit:

Hose 1

- High Volume Return
- 24 JIC Connection

Hoses 2 and 3

- Hose 2 - Open
- 20 JIC Connection
- Hose 3 - Close
- 20 JIC Connection

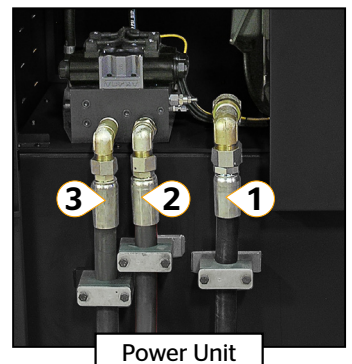
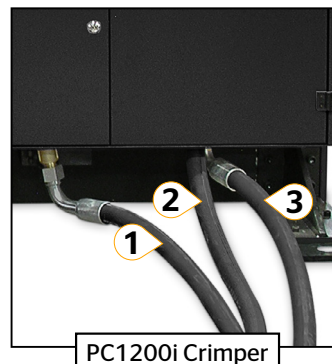

Notes:

- Make sure all the connections are tightened properly.
- All hoses are marked (1, 2, 3) for easy identification.

Voltage Tag Check: Check electrical circuit to be certain that it matches the crimper's requirements shown on the voltage tag attached to the crimper cord.

Notes:

- Plug the PC1200i crimper directly into the appropriate electrical circuit / wall outlet.
- Electrical Requirements:
 - 15HP/230V/3Phase (35 Amp)
 - 15HP/380V-415V/3Phase (20 Amp)
 - 15HP/440V-480V/3Phase (20 Amp)

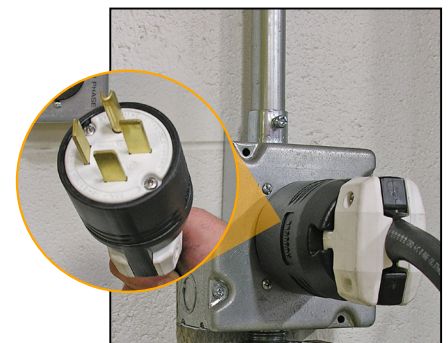

Caution: Do not run the crimper on an extension cord as low voltage can damage the motor and / or electrical components.

High-Level CrimpIQ™ Controller Capabilities

This version of the CrimpIQ™ controller is designed to take full advantage of the tablet interface and the connection to CrimpCloud®. CrimpCloud® is a web portal that provides users access to crimping and quality results captured in the CrimpIQ™ controller.

CrimpIQ™ Supports the Following Features

Ease of Use:

- Quick access to simple hydraulic and industrial crimping modes.
- Optional semi and full automatic crimping modes.
- New touchscreen interface with clear, easy to read icon driven operations.
- Integrated measurement tools: Choice of USB wired or Bluetooth caliper provide direct measure input for crimp, diameters and industrial hose measurements.
- Integrated help and tutorial guides for easy feature reference.
- Ability to easily favorite crimp specifications, complete with notes, for easy reference and accurate repeat crimping.
- Ability to track and report on crimp measurements and crimp pressures.

Integrated Crimping Tools:

- Full integration with MyCrimp®, for easy importing and handling of full crimp specifications.
- Integrated Industrial Crimp Calculator computes appropriate crimp diameter based on hose and fitting measurements.
- Support for foot pedal and electronic backstop.

Customizable:

- User account specific settings, such as choice of millimeters or inches as first choice for data entry.
- Create individual user logins (4-digit pins) to track usage and restrict machine configuration.

Connected:

- Wi-Fi or Ethernet connections, for easy reference to manufacturer web content straight from the crimper, automatic configuration backup and operations tracking.
- Ability to wirelessly update crimper software, providing up-to-date crimp specifications and new functionalities to crimper software.
- CrimpCloud® reporting to provide various reports on assemblies, crimps and machine maintenance.

Integrated Support and Maintenance:

- Simple on-crimper support ticket creation, with enhanced technical diagnostics for quicker and more responsive help when needed most.
- Built-in tutorials and training, including feature tutorials on every screen.
- Dynamic machine maintenance tracking and reporting, showing historical tracking of maintenance.
- Preventive maintenance alerts avoid machine downtime and costly repairs.
- Detailed on-machine availability of machine capacities.

Expansion Options:

- Bluetooth 4.0 supports Bluetooth calipers and other approved accessories.
- 8GB on-device storage, for support of crimp specifications or other future applications.

PC1200i Series Specifications

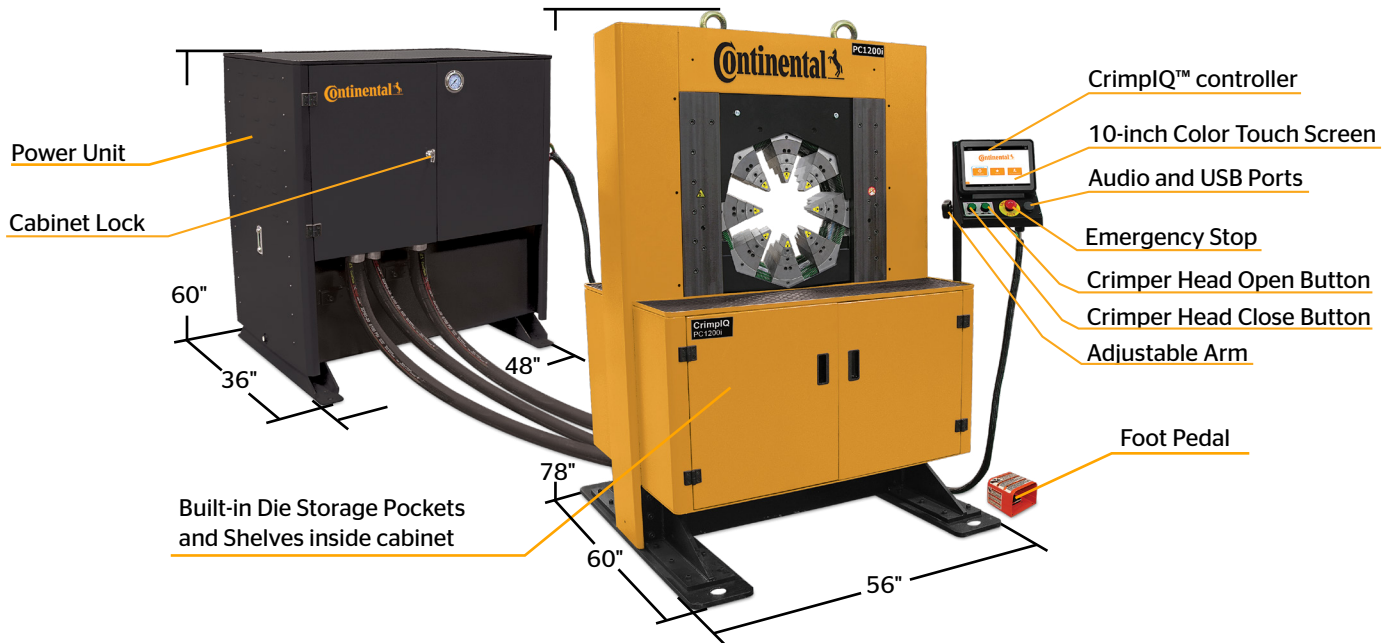

PC1200i Specifications
Crimping force: 830 Tons
Hydraulic hose capacity: 1/4" up to 3"
Industrial hose capacity: 4" up to 12"
Crimper size: L: 60" x W: 56" x H: 78"
Crimper weight: 10,000 lbs
Power unit size: L: 36" x W: 48" x H: 60"
Power unit weight: 2,000 lbs with oil
Power: 15HP/230V/3Phase (Standard) 15HP/380-415V/3Phase (Optional) 15HP/440-480V/3Phase (Optional)
Hydraulic die series: 99P
Adapter die series: 330mm O.D To 230mm I.D 230mm O.D To 160mm I.D 160mm O.D To 99 mmI.D
Industrial die series: 160S / 230XL / 330S / 330OB
Adjustability: Inch / Metric
Opening w/o dies: 489mm / 19.25"
Master die inside diameter: 330mm / 13"
Master die travel: 165mm / 6.5"
Reservoir capacity: 80 US Gallons
Oil type: ISO 46 Hydraulic Oil

PC1200i Series Specifications

PC1200i Crimper with CrimpIQ™ Controller



PC1200i Features



Continental CrimpIQ™ controller, the future of crimping at your fingertips.



10-inch color capacitive touchscreen and user-friendly navigation.

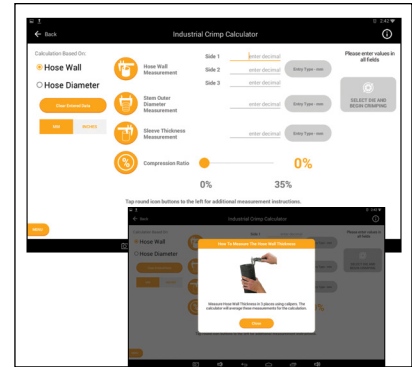

Intuitive screens lead the operator through the setup and crimping process.

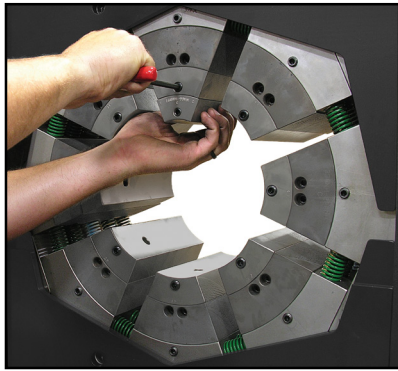

Quickly Interchangeable Adapter Dies.

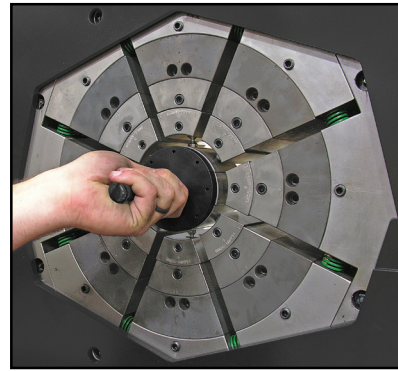

Quick Change Tool makes die changes a quick and simple process.

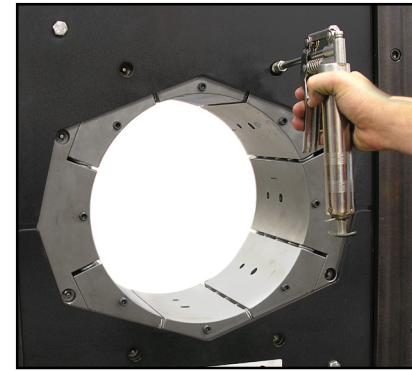

Easy grease maintenance through the lubrication fittings.



Continental CrimpIQ™ controller supports bluetooth calipers to input crimp diameter measurements. Saving time and entering accurate measurements.

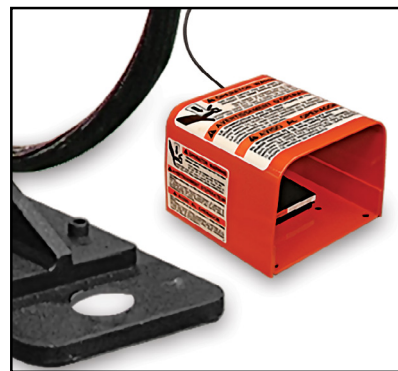

Foot Pedal for use in Semi and Full automatic mode.



Built-in Die Storage Pockets and shelves to keep frequently used die sets readily available.

Initial Crimper Setup

Overview

Before the crimper can be used for the first time, a brief setup process must be completed. This process sets some initial parameters, identifies this machine to the CrimpCloud® system and allows the user to confirm the Terms and Conditions for use of this machine.

This process only needs to be completed once when the machine is installed. After that, the machine will power up and be ready for use.

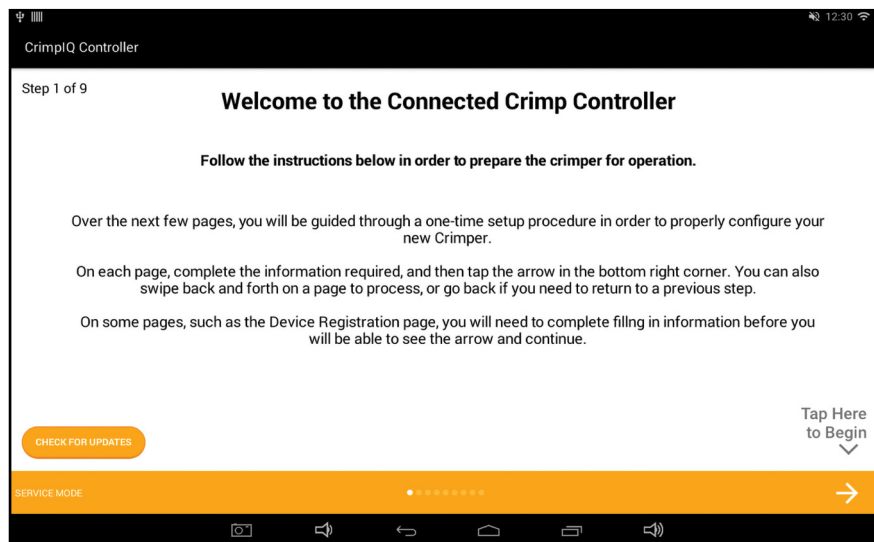

Initial Crimper Setup

PC1200i Crimper with CrimpIQ™ Controller

Crimper Operations

Logging In

To begin using the crimper, you must first login.

The crimper supports multiple users to allow tracking of activities as well as restrict access to some configuration type functions.

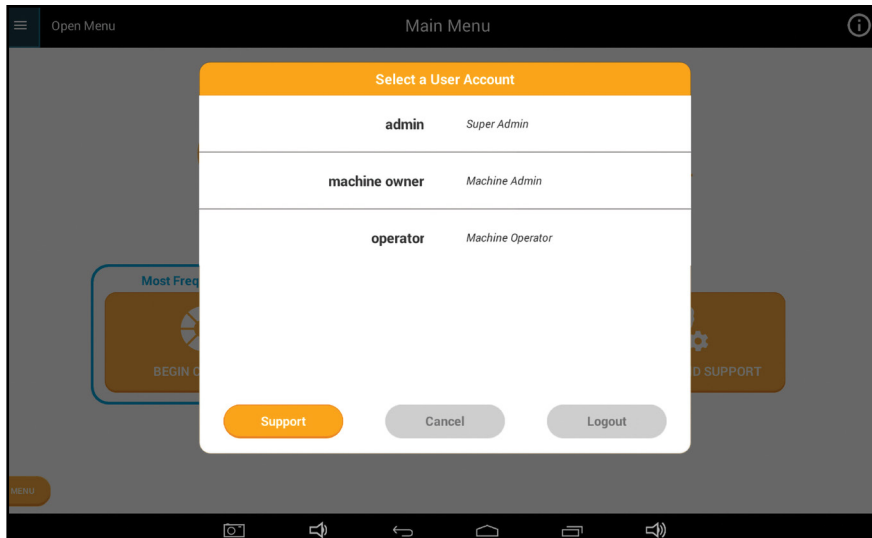

Default User Accounts

The system comes with 3 users already created: admin, machine owner and user. Additional accounts can be added if required using the machine configuration menu.

Pin codes listed below are defaults, and they can be changed by machine owners in the user menu:

If you have configured additional users, their names will appear in this list as well. Once you have logged in, you can begin using the crimper.

Admin: A private account for certified technicians and engineering maintenance.

Machine Owner: This account is an admin level account intended for the local administration. It has full access to all settings and functions. Default pin code is 9876.

User: This account has the permissions and capabilities to perform crimping operations but has limited access to settings and diagnostics/setup functions. Default pin code is 1234.

Note: *The system will automatically log users out of the system after the machine is idle for 1 hour. This feature can be disabled or configured in the Machine Configuration screen.*

Navigating the CrimpIQ™ Controller

This section provides an introduction to the controller screens and functions that are common throughout the application.

Basic Application Guide

This section outlines basic functions within the app that are common throughout the application. The basic outline and functionality is common throughout the application.

The screen is divided into the following sections:

Top Menu: This area of the screen provides high-level application and controller information and access to help and settings.

Main Screen: Main screen with information and functions related to this screen (directly linked to the screen title).

Left Menu: Provides access to information and functions that need to be available from everywhere within the application. Access this with the menu button or by “swiping” left to right from the left side of the screen.

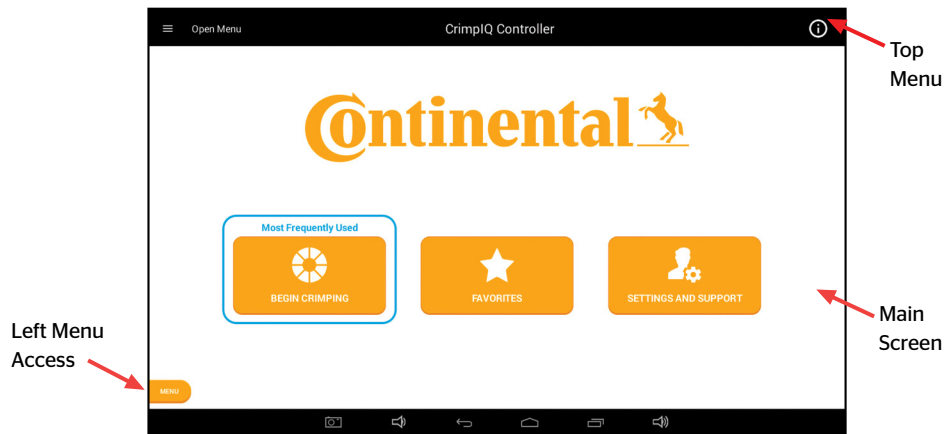

Top Menu

The top menu includes a screen title, access to menus and information.

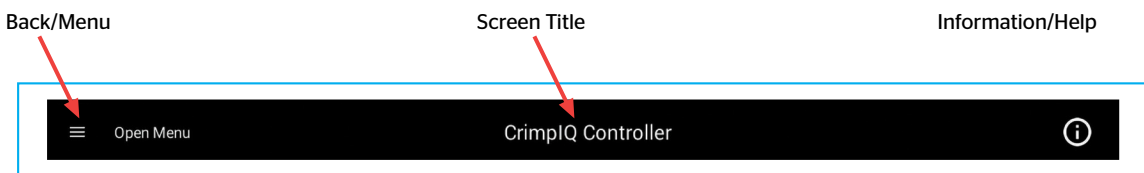

Back/Menu: This allows you to return one screen back (when you reach the main menu, it brings out the left slide-out menu).

Information/Help: This option brings up help information relevant to the specific location within the app.

Other: There are a few other status indicators that may be helpful.

- Right section displays Wi-Fi strength, Bluetooth status and machine time.

Left Slide-Out Menu

The left slide-out menu is available from anywhere within the Crimp controller app. It can be accessed by pressing the Menu button (always on the lower left side) or by swiping left from the left side of the screen.

Once opened, pressing anywhere on the right side of the screen (right of the left slide-out menu) will close the menu.

The left menu contains information and functions that could be used at any time within the application.

Left Slide-Out Menu Information

The left slide-out menu provides a quick status of the system. This information includes:

- Die Name:** Name of the die (if any) that is currently loaded in the machine.
- Position:** Position of the crimp head, relative to the die currently loaded.
- Target Diameter:** The crimp diameter target currently loaded into the machine. This is the diameter the crimper will close to given the size of the dies loaded into the machine.
- Previous Max Pressure:** Max pressure on the last successful crimp.
- Last Activity Sync:** The last time that the machine has synced with CrimpCloud®.

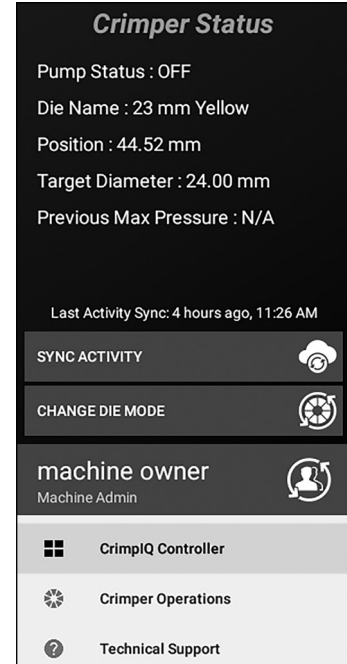

Left Slide-Out Menu Functions

The left slide-out menu provides functions that can be executed from anywhere at any time:

- Sync Activity:** Sync Activity sends the latest crimper activity up to CrimpCloud®. Last Activity Sync data and time described above detail the last successful data sync.
- Change Die Mode:** This mode allows the user to position the head to change dies. The machine tracks which dies are loaded and will update information according to which dies are loaded.
- "User Name"** Change user function. This button displays the currently logged in user and provides a function to login as a different user.
- Main Menu:** Return to the main menu of the application.
- Crimper Operations:** Return to the crimper operations menu.
- Technical Support:** Bring up the technical support function.

Using the Main Menu

This screen provides the main functions of the crimper.

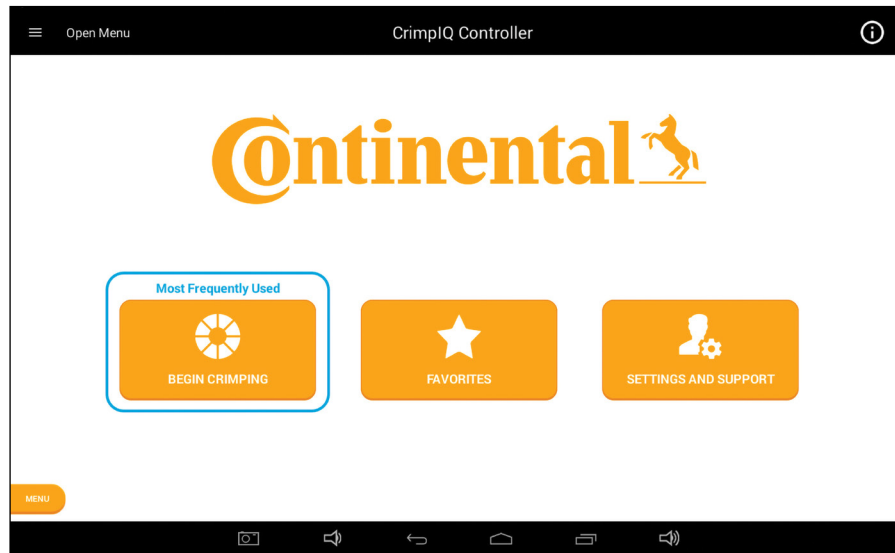

CrimplIQ™ Controller Main Menu Screen Options

Begin Crimping: This button brings up the functions to perform hydraulic and industrial hose crimping.

Favorites: The Favorites button provides users with direct access to favorited crimp specifications.

Setting and Support: This button brings up all of the support, information, training manuals and configuration options available for this machine.

Crimper Operations

Main Crimper Operations Screen

The crimper operations screen is the starting point for setting up a crimping operation.

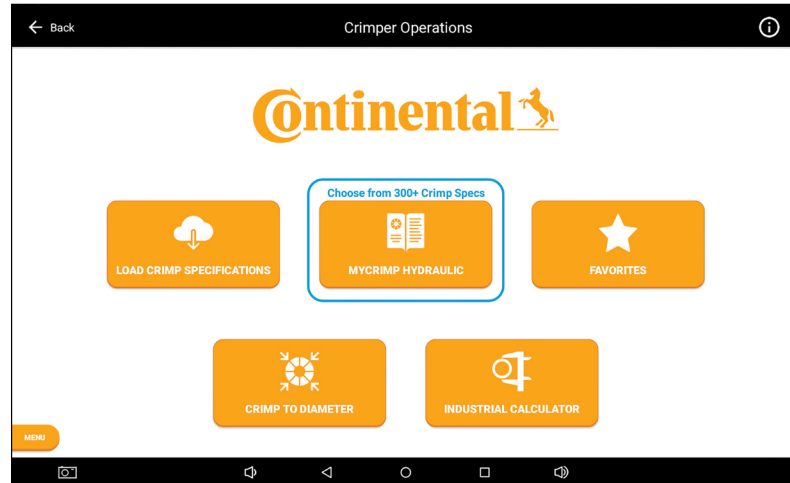

Favorites:

This function contains all of the crimp specifications that have been previously favored.

Crimp to Diameter:

This function allows the user to directly enter a crimp diameter. Once entered, the system will recommend a die and allow the user to proceed to Crimp Operations.

MyCrimp® Industrial:

This brings up an Industrial Crimp Calculator. This calculator can determine the crimper setup based on the hose diameter or hose wall thickness.

Load Crimp Specifications

This function allows the user to retrieve and load a crimp specification from MyCrimp®.



MyCrimp® - Search Screen

Use the Hose Type, Coupling Type and Hose Size to find the crimp specifications you need.



Key Functions of MyCrimp®

Hose Type:	Drill down into a list of hose types.
Coupling Type:	Drill down into a list of coupling types.
Hose Size:	Drill down into the list of hose sizes.
Crimper:	This is preset to the current crimper type and cannot be changed.
Favorite:	Allows the user to favorite selections and view them at the top of the list.
Clear:	The clear button and trash can icon clear previous selections and let the user begin a new search.
Total Crimp Specs:	Lists the total number of crimp specifications found that match the search criteria.
View Crimp Specifications:	Allows the user to view a list of matching crimp specifications.
Return to controller:	Allows the user to abort the MyCrimp® search and return to the controller.

Once you find the desired crimp specification, View Crimp Specifications will allow users to review the matching crimp specifications.

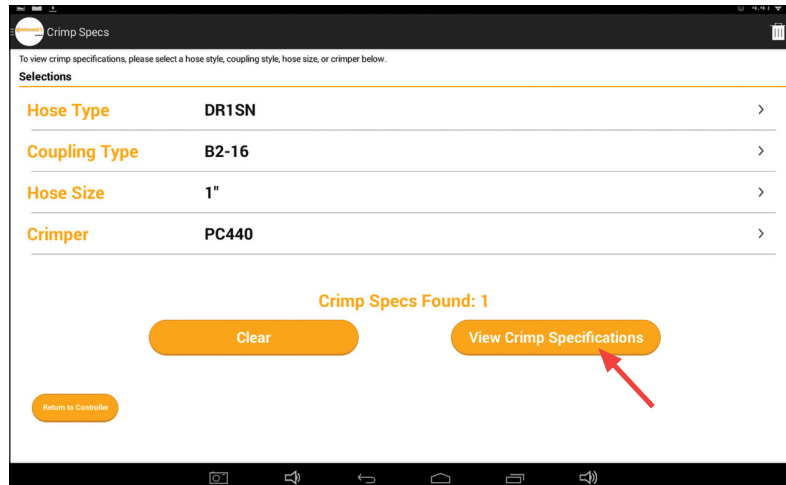

MyCrimp® - Results Screen

This view provides a review of the hose and fitting selected. Select "Begin Crimping" to begin crimping.

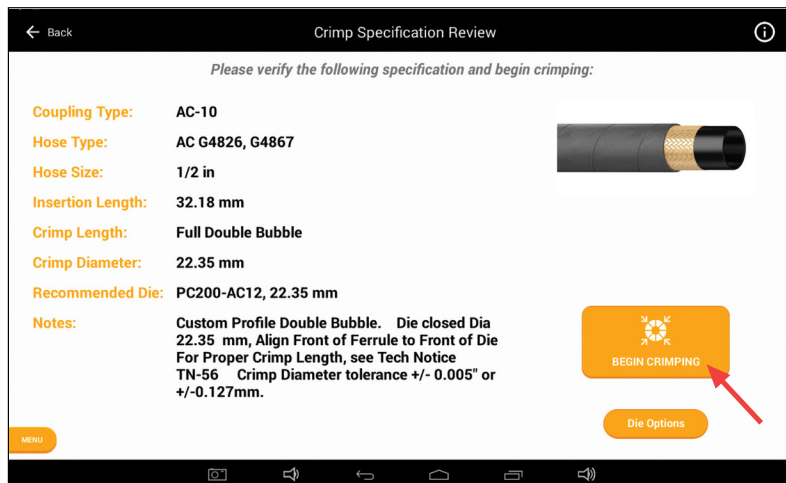

From the detailed view, users can view the full details of the crimp specifications.

Users can return to the previous screen with the Back button in the upper left corner or by using the "More Options" menu in the upper right to "Export Specification." An Export Specification button is also found below the specification details.

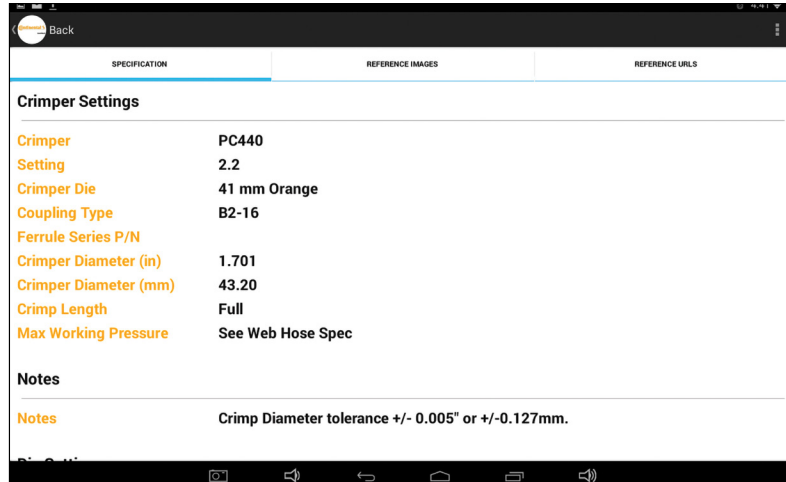

MyCrimp® - Crimp This Specification

Selecting "Crimp This Specification" will allow the user to confirm the crimp specification details.

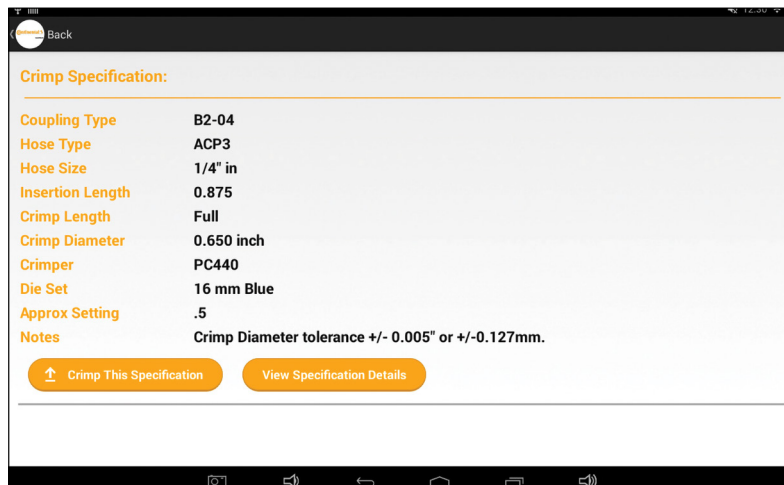

Managing Crimp Specifications

Begin Crimping: Select this option to have the controller configure the crimper and allow the operation to load/confirm the correct die is loaded.

Die Options: In special situations, the user may wish to use an alternative die. To accomplish this, select the Die Options button to bring up a list of all dies configured for this machine.

Crimp Specifications with Special Handling Requirements

There are cases where the user has to perform additional steps in order to select the correct crimp specification for the hose and fitting combination. In these cases, MyCrimp® will prompt the user with additional information. Users can then take the appropriate actions.

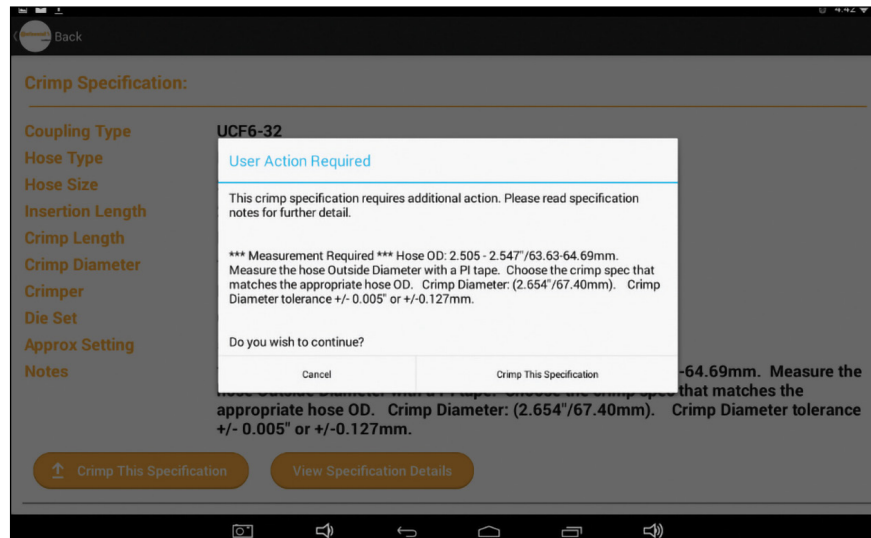

Favoriting Crimp Specifications

The user can save frequently crimped specifications for easy access and repeated crimping.

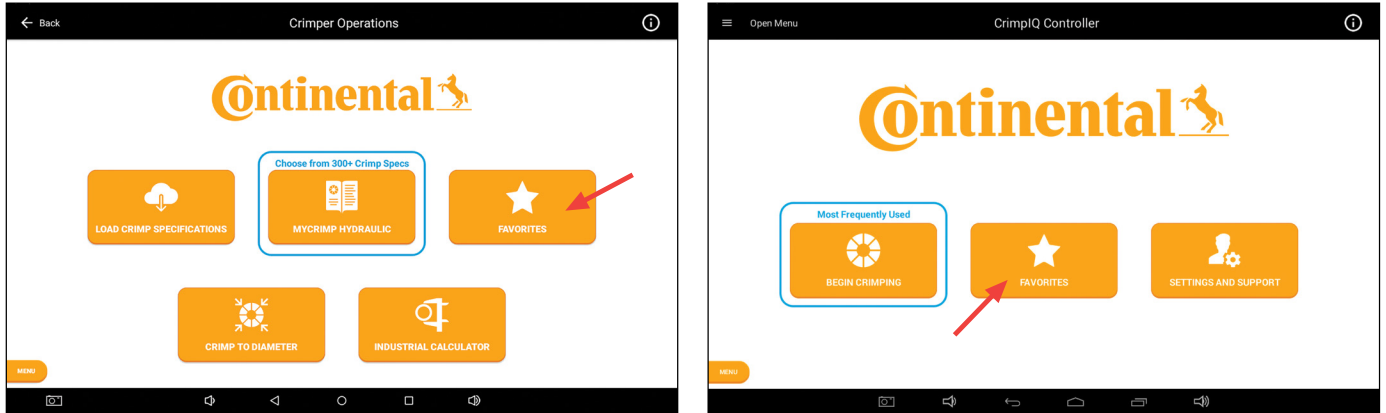

This brings up a list of all the favorites saved on this machine. This scrollable list can be sorted by date added (Recent), Favorite name (Name) or hose size.

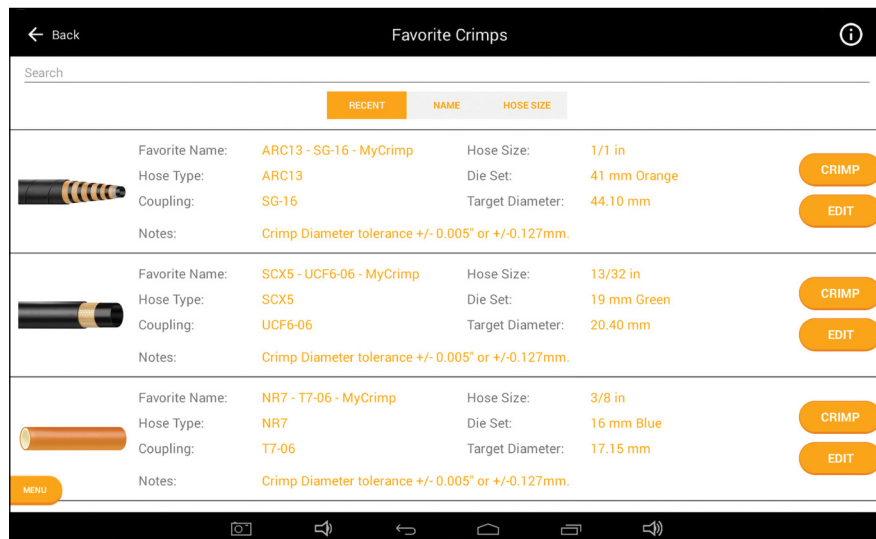

Editing a Favorite

Users have the option to edit the Favorite name and notes. You also have the option to delete favorites that are no longer needed.

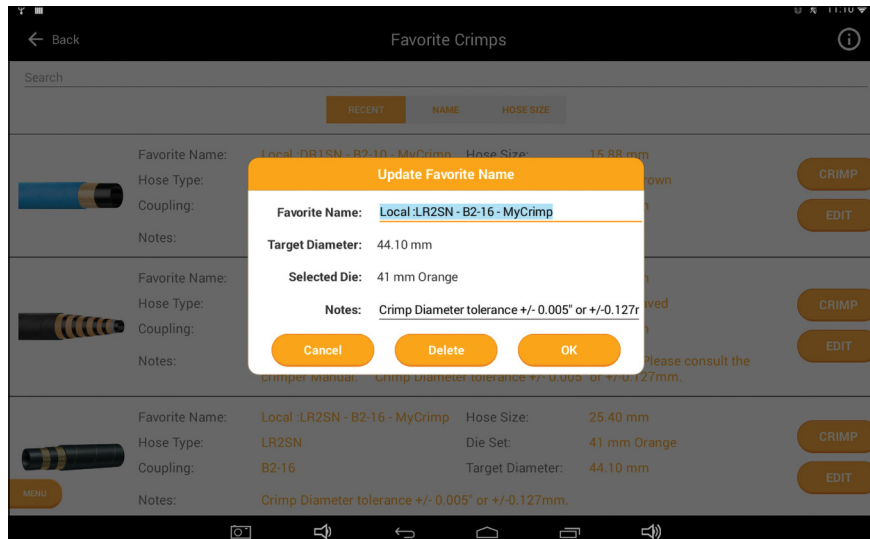

Favorite Special Handling

There are a subset of crimp specifications that require special handling. For these favorites, users must make an additional check to verify that the correct crimp specification has been selected. The system will automatically bring up a "User Action Required" dialog and ask the user for an additional confirmation (or cancel).

Note: For these specifications, the edit function does not allow the note to be changed.

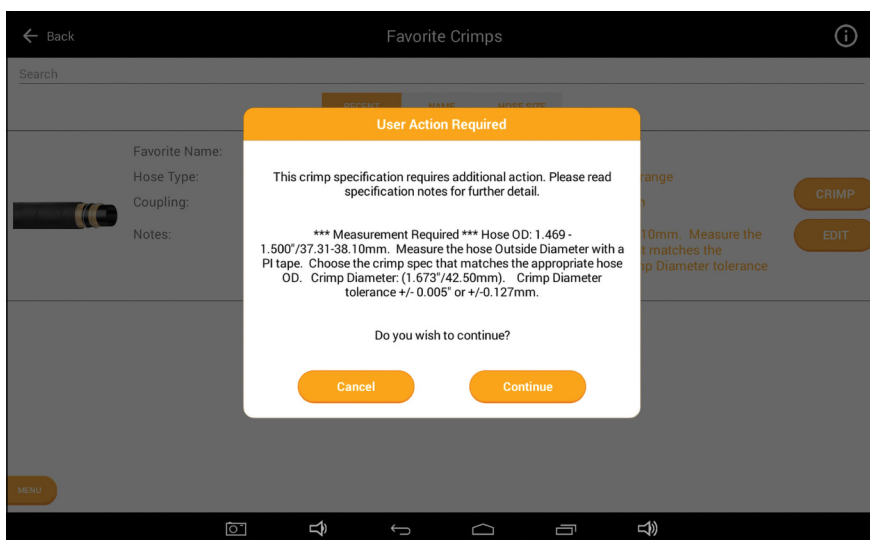

Crimp to Diameter

If you already have the crimp specification information, you can enter this directly and begin crimping. Simply choose the Crimp to Diameter option from the Crimper Operations page.

Enter the appropriate crimp diameter target (in inches or mm). As you enter a target diameter, the crimp automatically calculates the equivalent measurement in the other unit of measure.

The system will recommend a die and you can proceed to crimping.

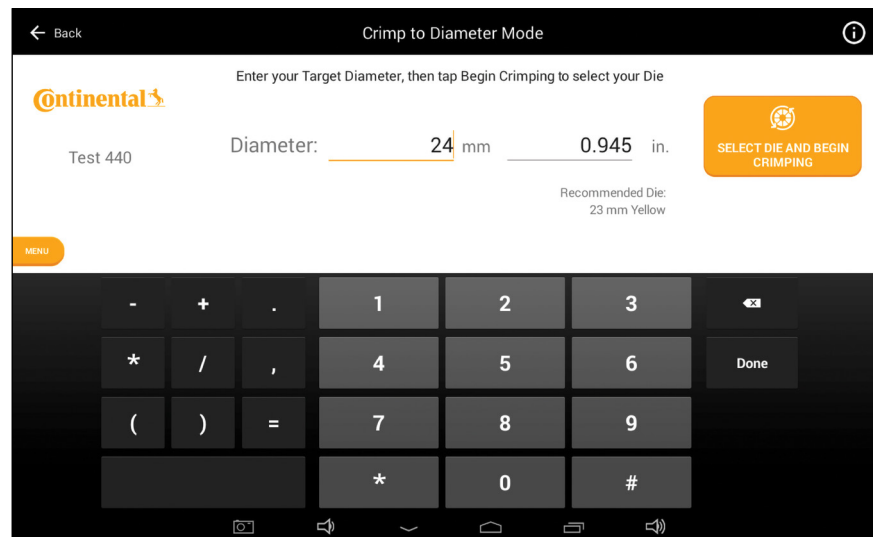
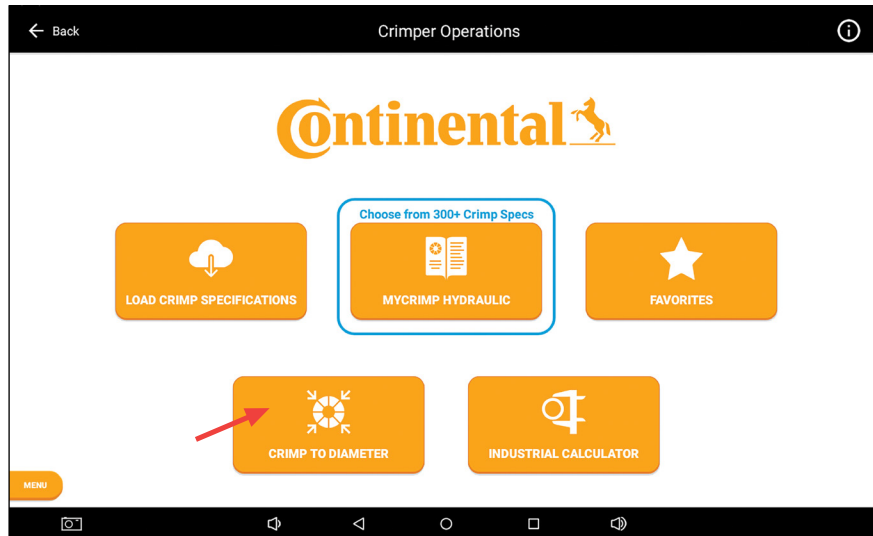

Note: If the keyboard is not visible, tap the Diameter data entry area and the keyboard will appear.

MyCrimp® Industrial Crimp Calculator

The Industrial Crimp Calculator allows users to enter information about the industrial hose, stem and sleeve, along with a compression ratio. The calculator will then calculate the appropriate crimp diameter.

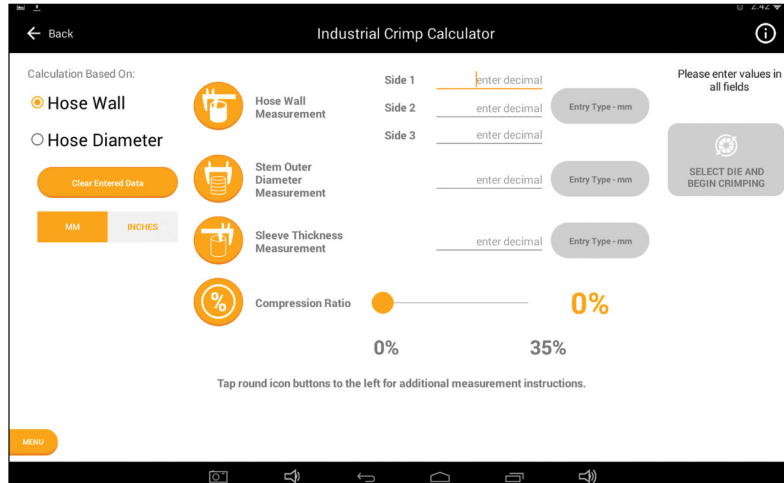

The calculator provides additional details on each required value. Press on the measurement icon and a more detailed description pops up.

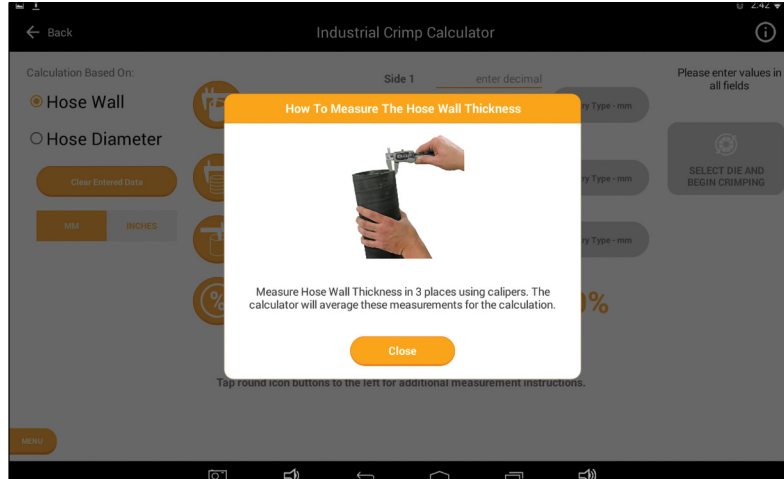

Entering Industrial Measurements

Hose Wall: Allows users to perform the calculation based on 3 measurements (averaged) of the hose wall thickness.

Hose Diameter: A single hose diameter measurement.

Stem Outer Diameter: The diameter of the stem.

Sleeve Thickness: The thickness of the sleeve.

Compression Ratio: Compression ratios are available from hose and fitting manufacturers.
Ratios must be between 10% and 35%.

As data is entered, the calculator will determine the final crimp diameter (users cannot proceed to crimping until all fields have information entered).

Once the data is entered and the calculation complete, you can proceed to crimping.

Beginning a Crimp

Loading Dies

Regardless of how the crimp specification/crimper was set up, the first step in crimping is to load the correct die into the crimper.

As part of the crimper configuration, the dies available to this crimper have been configured (see Managing Preset Dies on page 37). This pre-determined list of dies allows the crimper to determine which die to recommend for each crimp.

Crimp specifications and favorited crimp specs all include a recommended die. If that die is configured for this crimper, the user is prompted to install the recommended die.

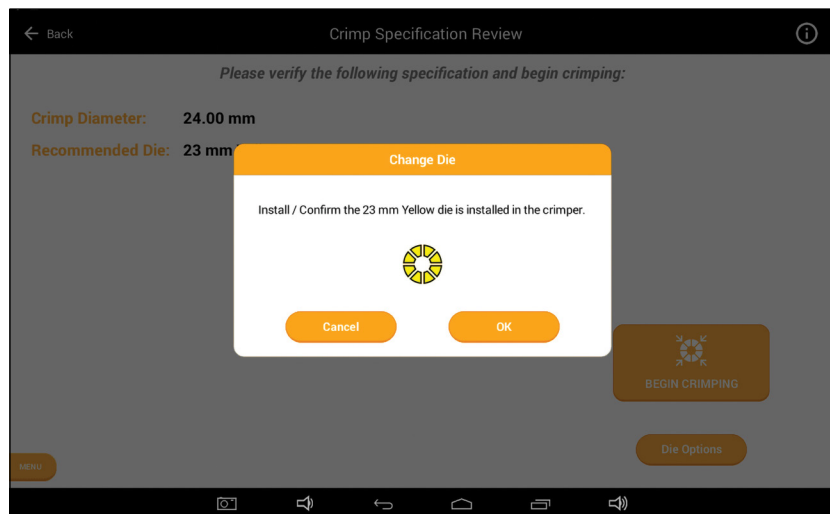
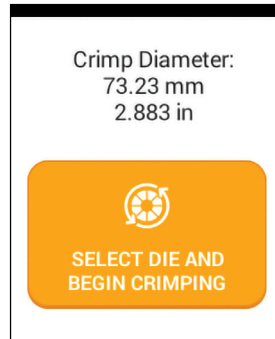

Notes:

- Continental dies use color coding to help the user select the correct die set.
- The crimper will always prompt the user to "Install/Confirm" that the die is loaded. Therefore, even if the recommended die is already loaded, the user will always be prompted to confirm that the correct die is installed in the crimper.
- While on the Change Die screen, the pump is on and the Open/Close button is enabled. The user can move the crimp head as required to install the dies.
- In rare situations, the user may need to override the recommended die. This can be done by pressing the Die Options button. This will bring up the list of available dies (described below).
- **Caution:** In Change Die mode, the crimper head will close to the die diameter.

Selecting a Die

If a non-recommended die or no die is set, the controller will prompt the user with a list of configured dies. The CrimpIQ™ controller will recommend a die that can crimp the required crimp diameter.

Once a die is selected, the machine will prompt the user to confirm/install the die in Change Die mode (described above).

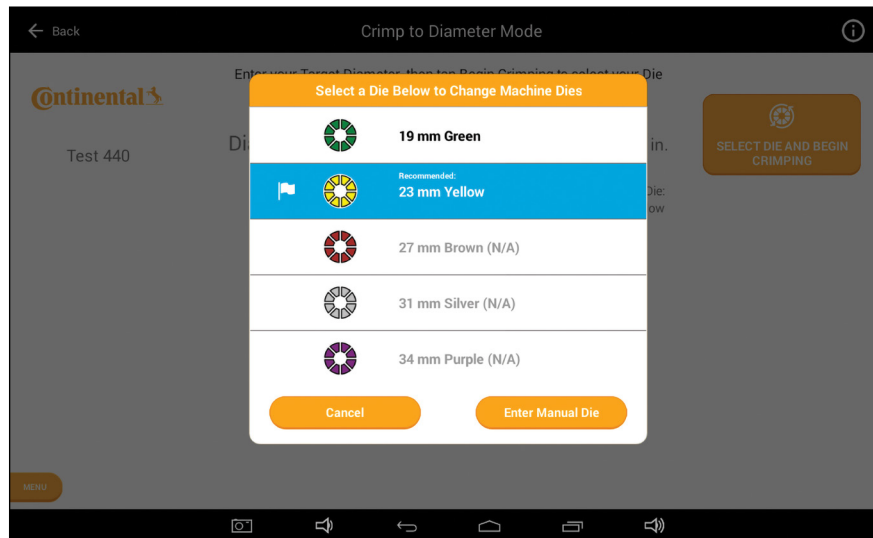

Notes:

- Dies that are grayed out are excluded because they are not capable of reaching the crimp diameter.
- This list is scrollable. You can slide the list up and down but, in general, the list will be centered on the dies that can be used for this crimp.
- This list is limited to the dies configured when the initial machine setup was completed (either in the factory or during the initial machine setup).
- If you have a die appropriate for this crimp but it is not in the list of dies, you can manually enter this die by choosing the Enter Manual Die option on the bottom right.
- If the selected die cannot crimp to the required crimp diameter, the crimper will display a warning.

Change Die Mode

When you select the die, the pump will start and the Open/Close buttons will work to allow you to load the die in the crimper. Once the die has been loaded, press the OK to continue.

Note: If the desired die is already loaded, simply press OK to continue.

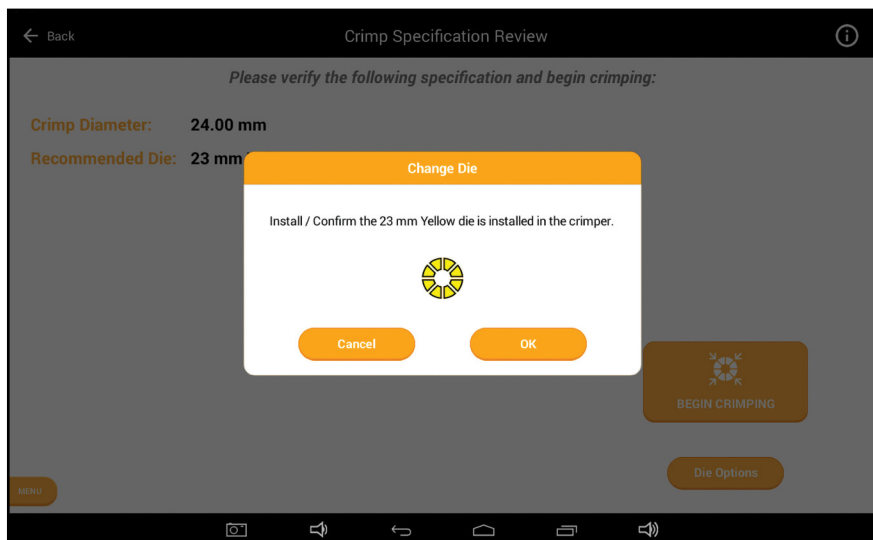

Crimp Operations

Performing the First Crimp

The first crimp always needs to be measured to ensure the crimp is within tolerance of the crimp diameter.

Note: Once the calibration crimp has been completed and an initial crimp diameter entered (manually entered or entered via USB CrimpIQ™ calipers), the crimper will automatically adjust to accurately crimp subsequent crimps.

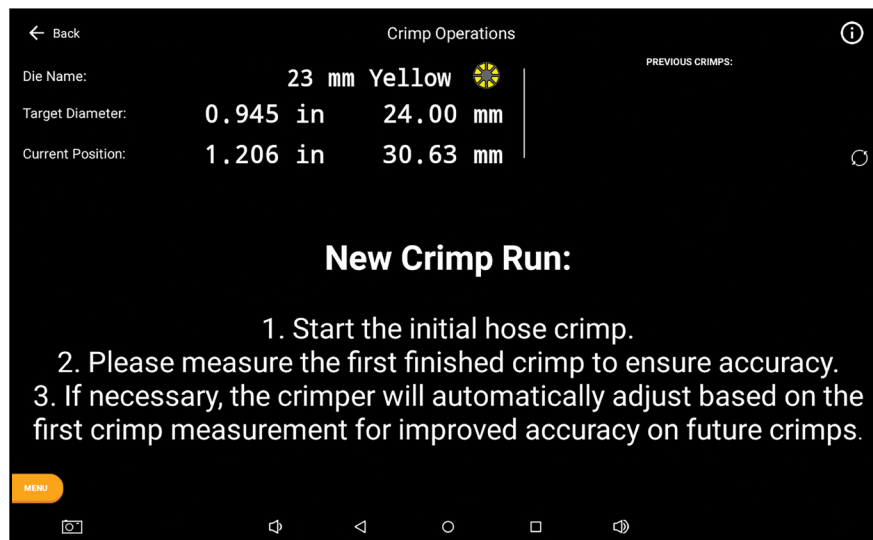

Measuring a Crimp

The crimper will always prompt the user to measure the first crimp. The crimper uses this measurement to adjust the crimper to correctly crimp the next crimps.

When prompted, enter the measured crimp diameter. Measurements can be entered in inches or mm (the cursor will be placed in either field based on the preferred units of measure setup in the machine configuration).

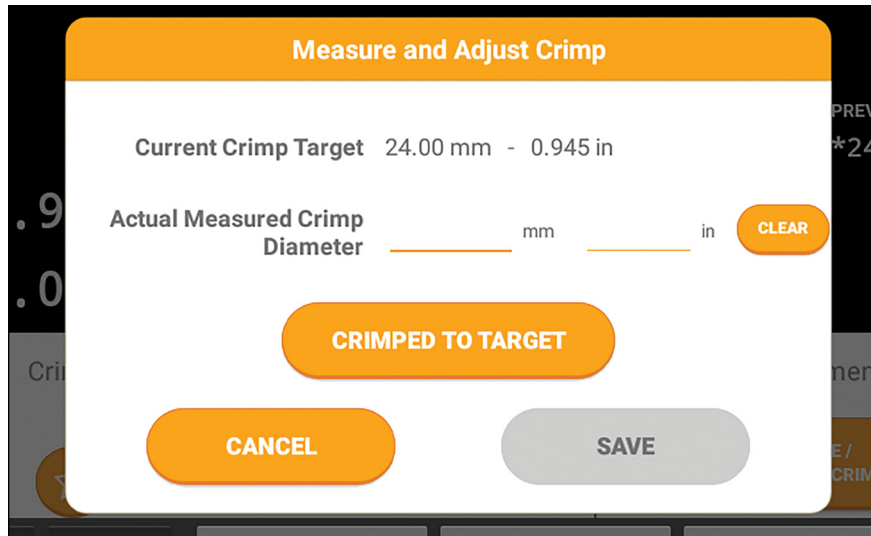

Notes:

- If the crimp diameter measurement matches the current crimp target, the user can press the Crimped to Target button to automatically enter the measurement with a single button press.
- If a value is incorrectly entered, simply press the clear button.
- Once the measurement has been entered, the Save button is enabled and saves the measured crimp diameter for quality assurance reporting.
- A keyboard will pop up on the bottom of the screen to allow users to enter crimp diameter data.
- If calipers are connected to the crimper, measurements can automatically be transferred into the measurement field.
- The preferred units of measure are set up per user and can be configured in the machine settings.

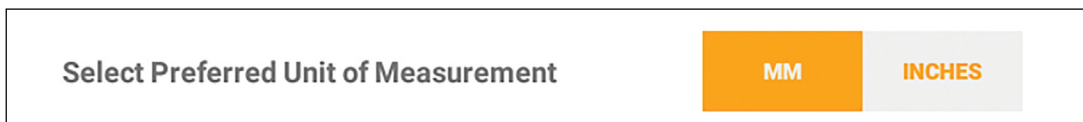

Crimp Operations Screen

This screen provides the main controls for operating the crimper. While on this screen, the pump is running and the Open/Close buttons are enabled (limited by Crimp Mode).

Crimp Operations Screen Sections

The operations screen is divided into 5 sections: Operations Information, Crimp Detail Panel, Crimp Mode, Crimp Settings and Crimp Management.

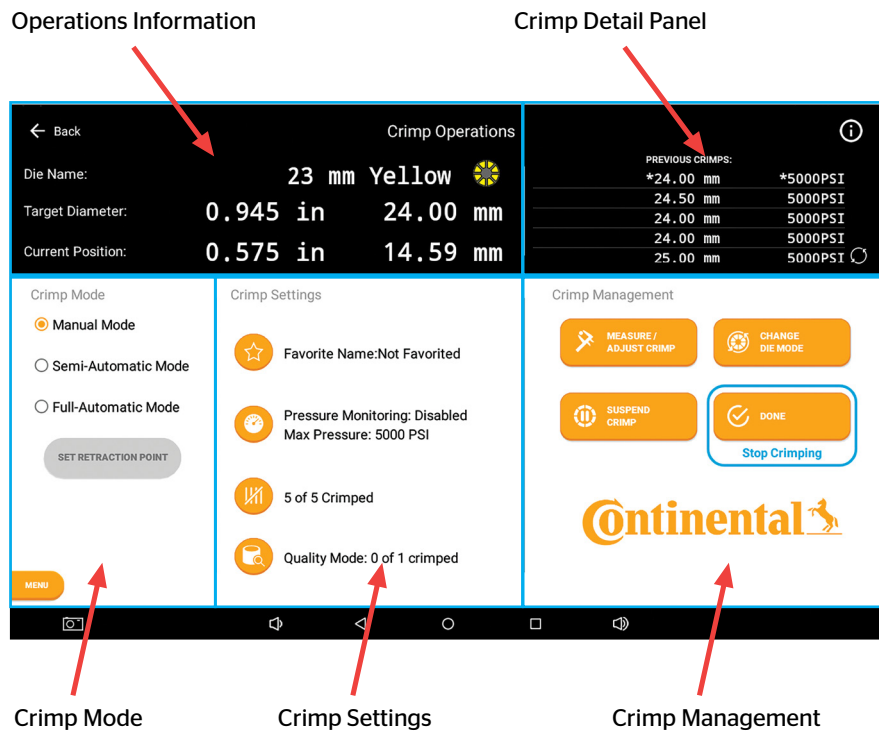

Operational Information

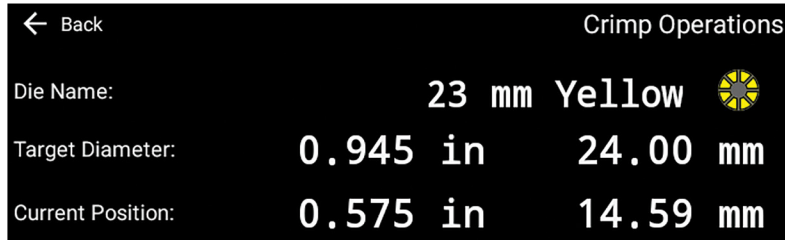

Die Name: The name of the die that is currently installed in the machine.

Target Diameter: The diameter the machine is set to crimp to.

Current Position: Current die opening in inches and millimeters.

Crimp Detail Panel

This area of the screen provides the user with additional information about the crimping processes. The data in this area rotates through a series of screens with different information. Users can cycle through each view with the icon in the lower right section of this screen area.



Last 9 Diameters: A list of the last 9 crimp diameters measured/entered into the CrimpIQ™ controller.

Last 9 Pressures: The last 9 maximum crimping pressures measured in PSI.

LAST 9 DIAMETERS:			
*24.00 mm	24.00 mm	24.00 mm	
24.00 mm	24.00 mm	24.00 mm	
24.00 mm	24.50 mm	25.00 mm	

LAST 9 PRESSURES:			
*5000PSI	5000PSI	5000PSI	
5000PSI	5000PSI	5000PSI	
5000PSI	5000PSI	5000PSI	

Note: The most recent is noted with a "*"

Note: The most recent is noted with a "*"

Combined View: This view combines the measurement and the max pressure view into one.

Note: Users may not be required to measure every crimp.

PREVIOUS CRIMPS:	
*24.00 mm	*5000PSI
24.50 mm	5000PSI
24.00 mm	5000PSI
24.00 mm	5000PSI
25.00 mm	5000PSI

Crimp Spec: Hose, fitting and hose size information when loading a MyCrimp® specification.

SPEC INFORMATION:	Hose Type:	DR1SN
	Coupling Type:	B2-16
	Hose Size:	1.000 in 

Hose Image: If a hose image is available, this image will be displayed.

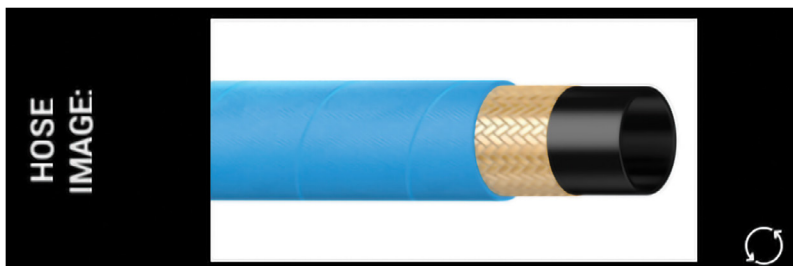

Spec Notes: This view shows the crimp specifications notes.

NOTES:	Crimp Diameter tolerance +/- 0.005" or +/-0.127mm.
--------	---



Industrial Crimp: This view summarizes the values entered into the Industrial Crimp Calculator.

Hose Wall Average:	2.04 mm
Stem Outer Diameter:	22.00 mm
Sleeve Thickness:	5.50 mm
Compression Ratio:	21% 

Crimp Mode

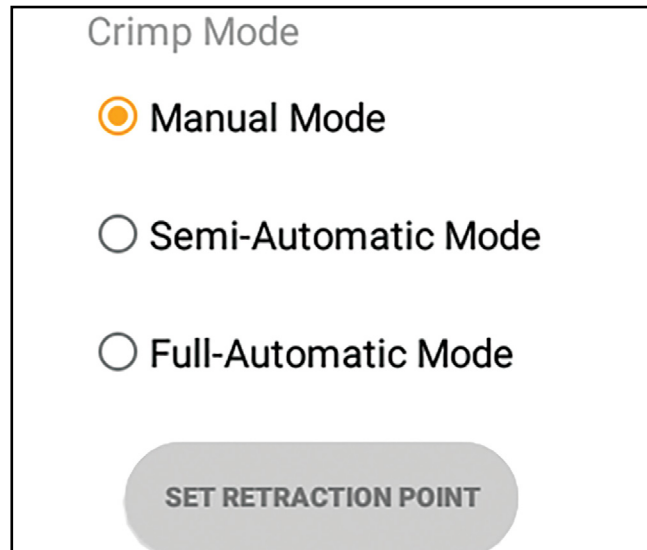

The crimper can operate in any of 3 different modes:

Manual Mode: Use this mode to manually Open/Close the head. Holding the Close button will close the head to the target position and no further.

Semi-Automatic Mode: This mode allows the user to manually close the head to the target position. Once the crimper reaches the target position, the crimper will automatically open back to the retraction point.

Full Automatic Mode: This mode allows the crimper to complete a complete cycle (close then open) with just a single push of the close button. Once the hose and fitting are correctly positioned, press the close button once and the crimper will close to the target position and then automatically open back to the retraction point.

Note: In either of the automatic modes, the foot pedal can also be used in place of the Close button.

Crimp Information

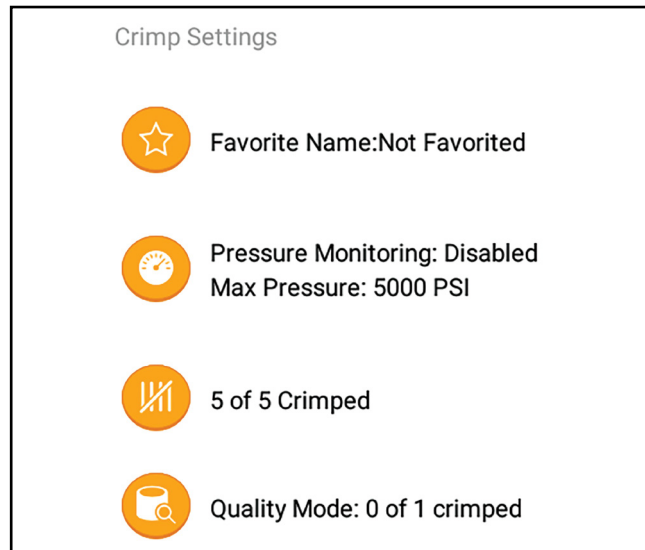

The Crimp Settings section contains status information and also a number of configurable settings that the user can change to adjust the crimp run.

Note: Each of these information areas can be configured by pressing the icon to the left of the information.

Favorite:

If this crimp specification has been saved as a favorite, the name of the favorite will be displayed here. To save a new favorite, simply press the favorite icon on the left.

PSI Monitoring/ Max PSI:

The CrimpIQ™ controller has the option to monitor the crimping pressure and alert the user if the PSI is out of range. Press the PSI icon to configure the target PSI and tolerance.

Crimp Count:

The CrimpIQ™ controller keeps track of the crimps completed. By default, this count goes up but you can also set it to count down. This is configured using the count icon on the left. Users also have the option to “bump” the count up or down if needed.

Quality Mode:

Quality mode automatically stops the crimping process after a specified number of crimps and prompts the user to measure the crimp diameter.

Crimp Management Function Buttons

This section provides buttons to configure and operate the crimper.



Measure/Adjust Crimp:

This button allows the user to measure and record the crimp diameter. When activated, the user can enter a crimp diameter measurement.

Change Die Mode:

This mode allows the user to change die.

Suspend Crimp:

Suspend Crimp is intended to put the crimper in a safe mode when the user needs to step away from the machine for a short time. While suspended, the pump is turned off and the Open/Close buttons are disabled.

Done:

This button should be used when the user has finished all crimps with these settings.

Settings and Support

In addition to the basic crimping operations, the CrimpIQ™ controller offers a number of other capabilities.

These include:

Machine Configuration: Crimp setup/configuration page with all of the configurable options of this device. See [Machine Configuration](#) below.

Support: Support page allows users to request support directly from the machine. See the [Support](#) below.

Manufacturer Website: Access to all of the information on the Continental corporate website. See the [Manufacturer Website](#) below.

Training Manuals: Direct access to setup, guides and training manuals for the machine and controller. See [Training Manuals](#) below.

Machine Information: Informational pages that provide users with basic machine stats and operational information.

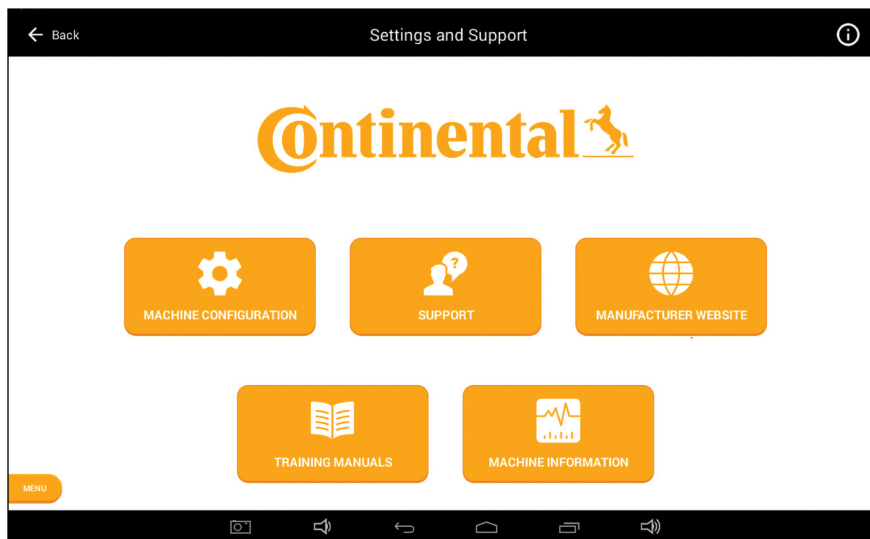

Machine Configuration

The CrimpIQ™ controller has a number of configuration options that allow the machine operation to be customized to meet the needs of each installation.

Main configuration functions are grouped into menu options at the top of the page. The rest of the configuration screen provides access to all the remaining configuration settings.

Notes:

- The options available vary by user type. Operators have very limited options and Machine Owners have access to all options.
- After making configuration changes, the CrimpIQ™ controller will attempt to back these changes up to CrimpCloud®.

This backup requires an Internet connection to complete.

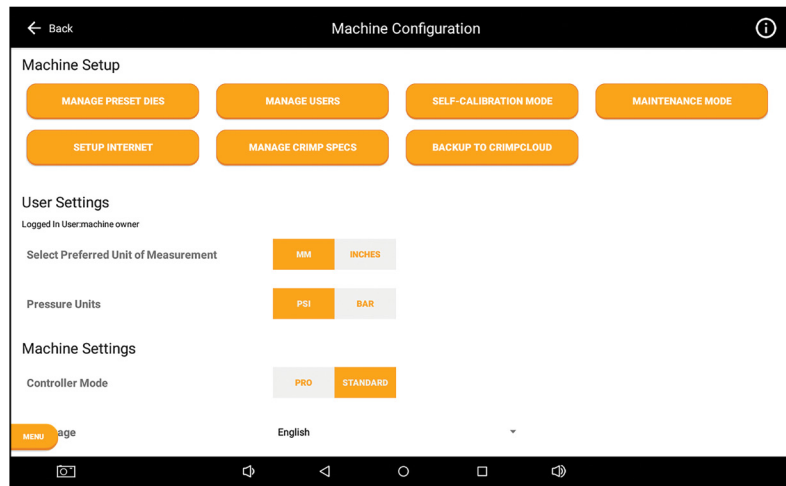

Machine Configuration Options

Manage Preset Dies:

Setup the dies that are available for crimping on this machine. See [Manage Preset Dies](#) above.

Manage Users:

Edit and setup machine users. See [Manage Users](#) above.

Self-Calibration:

Check the crimper calibration. See [Self-Calibration Mode](#) above.

Maintenance Mode:

List of maintenance tasks, schedules and due dates for machine maintenance. See [Maintenance Mode](#) above.

Setup Internet:

Configure and verify a tablet Internet connection. See [Setup Internet](#) above.

Backup to CrimpCloud®:

Backup CrimpIQ™ controller configuration to CrimpCloud®. See [Backup to CrimpCloud®](#) above.

General Configuration:

Other Configuration settings. See [General Configuration](#) above.

Managing Preset Dies

This screen provides a list of all of available dies for this crimper. Administrators can set each die to Not Purchased/Purchased to allow the CrimplIQ™ controller to filter the list of dies the user sees to only dies that are available with this machine.

Each die has a name, type, size in inches and size in mm. If there is also a color code associated with the die that is displayed.

Administrators also have the option to create additional dies. Select the “Create New Preset Die” button and setup additional dies.

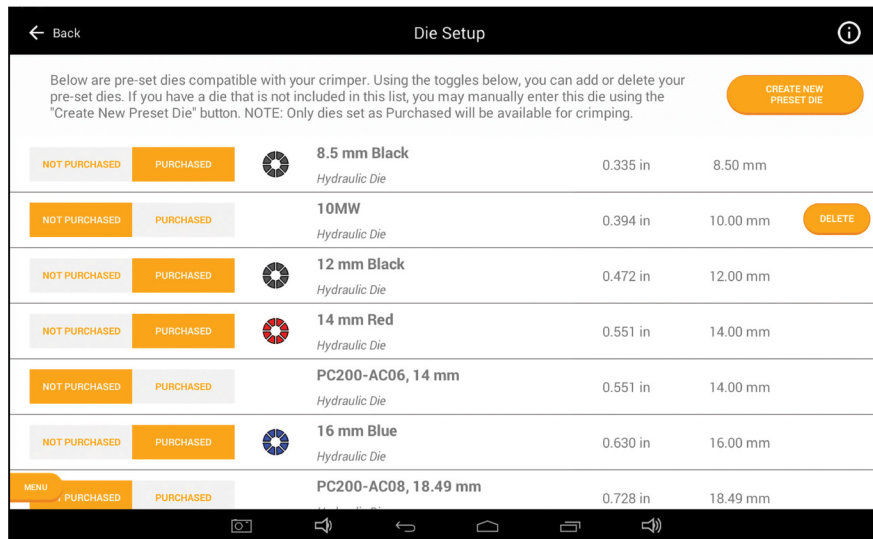

Managing Users

The crimper comes configured with three user accounts but Administrators have the option to setup additional users. Additional users can be useful to track what each user/admin is doing on the machine. Information on the default users is available in the Key User Information.

This setup screen allow Administrators to create new users and edit existing users.

Edit User: User name, 4 digit passcode and user type can be changed with this menu.
This is where an Administrator would reset the pin for a user who has forgotten their pin.

Create New User: Enter the user name, 4 digit passcode and user type to create a new user.

The CrimpIQ™ controller has been configured with multiple user types. Each type has different capabilities within the crimper. The goal is to provide users with all the privileges they require to do their tasks but no more.

Machine Admin: This is the highest privilege user type that can be configured. This user type can change all machine settings, access all support information and perform all crimp operations.

Machine Tech: This type has privileges to maintain the machine but cannot perform crimping tasks.

Supervisor: This type has privileges to monitor machine operations but cannot perform maintenance tasks.

Machine User: This type has privileges to use the machine, perform all crimping related tasks and has limited ability to change machine configuration.

Self-Calibration Mode

Self-calibration is a built-in test that verifies the accuracy of the crimper is within tolerance of its initial factory setup. If the test fails (out of tolerance), a warning message is displayed showing the difference from its initial set point.

To run the test, follow the instructions on the screen. At a high level, the test flows as follows:

- Load dies into the crimper (any standard hydraulic dies work). Make sure the crimp head is at least 1/3 open.
- Begin the self-calibration mode. This will prompt the user the press the Close button. The test then runs automatically and returns a success/failure result.

Default User Accounts

To learn more about Default User Accounts, refer to page 10.

Maintenance Mode

This machine keeps track of a number of different periodic maintenance tasks. Tasks are based on machine model.

Maintenance tasks are either triggered by the number of crimps or the number of days since the last maintenance.

Tasks include: Check Hydraulic Oil, Grease the Crimper, Perform Self Calibration and Data Synchronization. Most of these are self-explanatory with the exception of Data Synchronization (update crimp specification, check for application updates and sync data with the CrimpCloud®).

Maintenance Task	Last Performed	Next Performance	Actions
Check Hydraulic Oil <i>Frequency: 30 Days</i>	Aug 10, 2018	Sep 9, 2018	RECORD
Data Synchronization <i>Frequency: 90 Days</i>	Aug 10, 2018	Nov 8, 2018	PERFORM
Grease <i>Frequency: 500 Operations</i>	500 crimps	1000 total crimps	RECORD
Self-Calibration <i>Frequency: 30 Days</i>	Aug 10, 2018	Sep 9, 2018	RECORD

Notes:

- When a maintenance event is triggered (by crimp count or date), the user gets a popup indicating that the maintenance needs to be performed. To limit interference with operations, tasks can be delayed until a later date (Snoozed).
- Maintenance tasks are either triggered by the number of crimps or the number of days since the last maintenance, based on the requirements of the task.
- Users can come to this Maintenance Mode screen and perform maintenance tasks or wait for the popup alert.
- Recording a maintenance task provides the user with an opportunity to add notes. The logged in user and date/time are recorded along with the maintenance task.
- A complete history of maintenance performed is also available via the History button on the Maintenance Mode screen.

Setting Up an Internet Connection

This process allows users to configure/verify Internet connections. An Internet connection is not required for day-to-day operation but is beneficial. This section describes how to configure different types of Internet connections and verify these connections are working.

Using an Ethernet Connection

Plug the Ethernet cable into the base of the controller. The tablet will take a few moments to configure the connection. Once successful, the connectivity status will turn green.

Using a Wi-Fi Connection

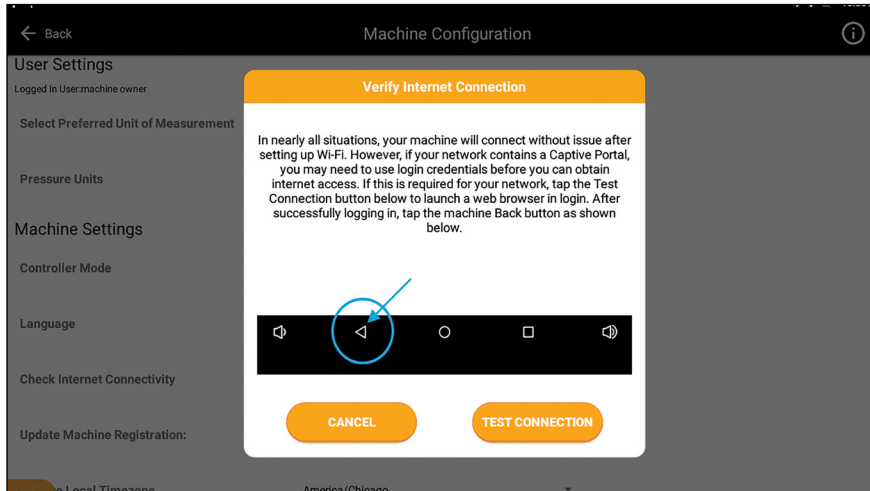

Initiating the Wi-Fi setup process brings the user to the standard Android Wi-Fi setup screens. Choose the appropriate Wi-Fi Network, enter in any required credentials and connect.

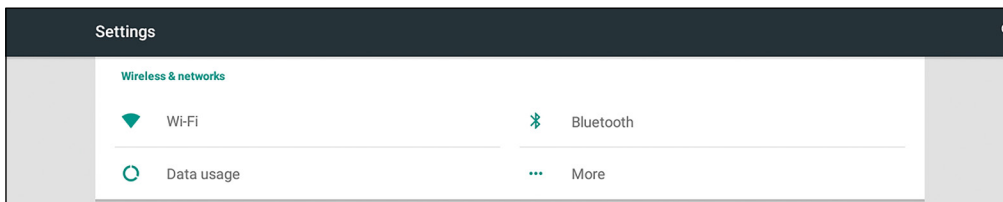

When the connection has been established, use the return arrow to return to the CrimpIQ™ controller application.



Connecting to a Captive Portal

Some customer locations have restrictions on which machines can connect to the company’s internal network. If this is the case, see the additional connection options section below.

Verifying Connection Status

When the Internet connection has been successfully established, the connection status will change to a green check mark. Please verify the connection before moving on to the next step.

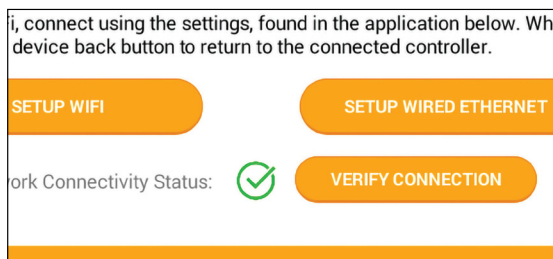

Testing Proper Connectivity



VERIFY CONNECTION

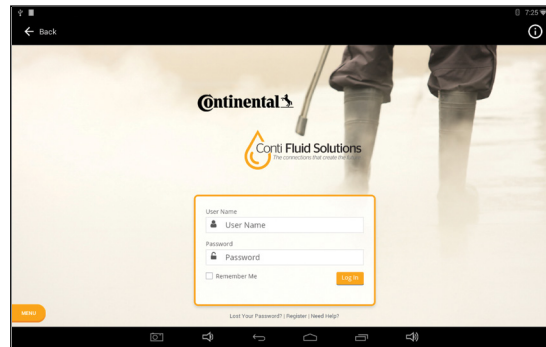

You can use the “Verify Connection” button to verify that the crimper can reach the Internet. Users should see the ContiFluidSolutions home page. If you don’t see this page, please contact your network administrator to enable access from the CrimpIQ™ controller to the Internet.

Once the CrimpIQ™ controller is connected to the Internet, use the back button to go back to the setup process and then continue to the next step by pressing the arrow in the bottom right of the screen.



Additional Connection Options

In some cases, network administrators may restrict which machines can access the company network. There are 2 alternative connection options to complete the Crimp setup process:

1. Temporarily connect to a guest network:

The controller supports connecting to guest networks to complete the installation. The CrimpIQ™ controller needs an Internet connection but does not require access to any internal company resources. A guest network can be used to complete the setup and update processes for the controller. Simply enter the guest network credentials and the setup can continue.

- a. Enter the guest Wi-Fi credentials (via the Android Wi-Fi setup screens) and verify the connection is active (as described above). The setup process only takes a few minutes after which the Wi-Fi connection is not needed.
- b. Some facilities Wi-Fi connection use a web page to request user Wi-Fi login credentials. The controller supports this. After selecting the appropriate network, return to the CrimpIQ™ controller setup screen. Use the verify connection option to bring up the ContiFluidSolutions home page. The local network will then prompt for the required credentials.

2. Connect with a hot spot from a mobile device:

In some cases, network administration policies will not allow the CrimpIQ™ controller to access any network. In that case, users must setup a Wi-Fi hotspot and use this connection to complete the setup process.

Internet Access Requirements

The CrimpIQ™ controller was designed to work with or without a dedicated Internet connection. If a dedicated connection is not available, all of the essential crimping functions will work. The Internet associated features (ContiFluidSolutions home page, support tickets, reporting) will not work because they require an active Internet connection to operation. Periodically, users will be prompted to connect to the Internet to allow the CrimpIQ™ controller to sync information with CrimpCloud®. This sync ensures the crimper has the latest software, crimp specifications and updates. It also ensures the machine configuration and operational history is backed up to CrimpCloud®. Operational information is used to generate reports and other features available to users from CrimpCloud®.

Backup to CrimpCloud®

CrimpCloud® has the ability to provide reports on crimper operation and maintenance. In addition, it stores the configuration of the CrimpIQ™ controller (users, dies, favorites). Saving this configuration allows Continental to replace the controller tablet, pre-loaded, with all the backed up configuration. Simply press “Backup to CrimpCloud” and the backup is performed.

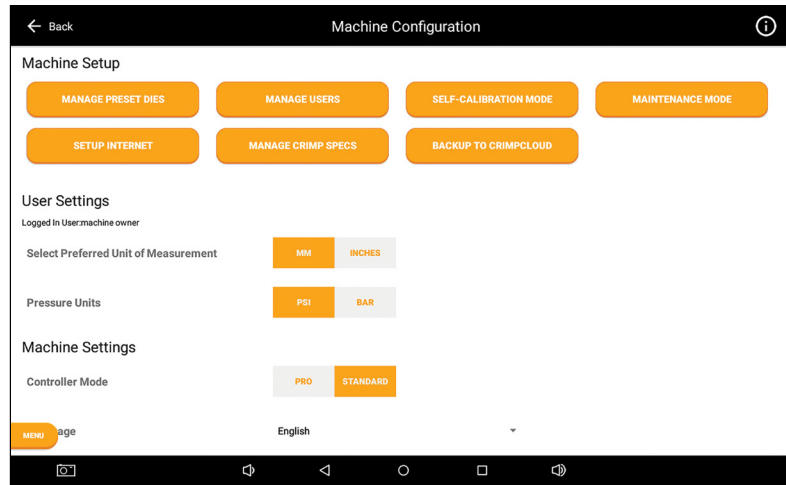

General Configuration

The following is a collection of other settings available to Administrators to configure the CrimpIQ™ crimper to meet their specific needs.

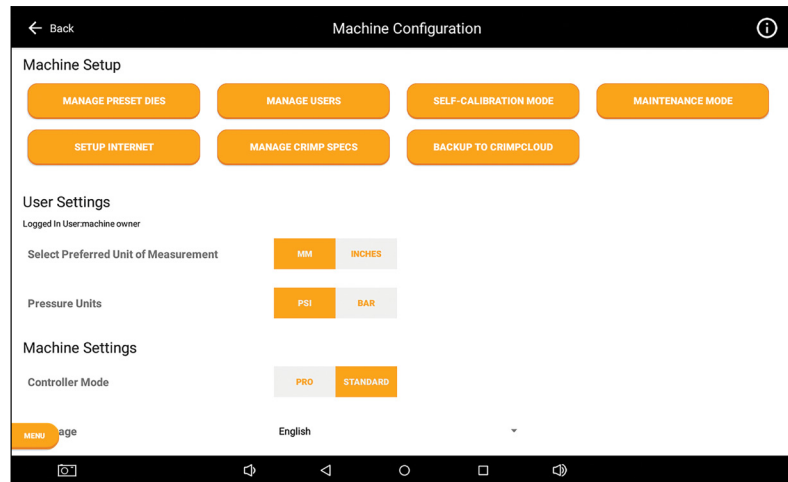

User Settings - Preferred Units:

Each user can have own settings for default units. Default units determine which data entry field the cursor is placed in.

Update Machine Registration:

The Machine registration information provides the Continental support team with location and contact information used to support the crimper.

- Check Internet** This feature is used to verify the Internet connection. A green check mark indicates a successful network connection via Ethernet or Wi-Fi. A red exclamation point (!) indicates there is no network connection. There are circumstances where the Wi-Fi signal is present but the tablet still cannot access the Internet. To confirm the connection to the Internet, the “Verify Connection” brings up the ContiFluidSolutions home page in a web browser. If the site comes up, the CrimplIQ™ controller has a connection to the Internet.
- Change Local Time Zone:** Output field to let Administrators know which time zone the tablet is set to. This information is important for logging and reporting. This can be changed by selecting the correct time zone from the drop down list.
- Dual Pump:** Larger crimpers has a dual pump configuration to improve the speed of operation.
- Slow Start Offset (mm):** This setting indicates how far above the target crimp the pump/crimper switches from fast to full power crimping mode.
- Note: The default value generally does not need to be changed.*
- User Timeout Length:** Length of time idle (in minutes) before the machine automatically locks and requires a pin to login.
- Note: This feature has an option to turn off (disables user timeout).*
- Die Selection Tolerance:** This setting helps the crimper recommend the best die for each crimp. This tolerance value ensures that the crimper does not recommend a die that is too close to the target crimp diameter that cannot crimp to the required diameter.
- Note: The default value generally does not need to be changed.*
- Pressure Compensation Mode:** On/Off for Pressure Compensation. Pressure compensation uses the crimp pressure as feedback to improve the accuracy of the first crimp.
- Note: Turning this feature on or off impacts the behavior of the first crimp in crimp operations. It turns the calibration crimp screen on or off, respectively.*
- Screen Brightness:** Adjust the screen brightness for best viewing.
- Enable Crimp Target Reached Popup:** On/Off for a popup letting the user know that the crimper has successfully reached the target.
- Enable Crimp Target Reached Beep:** On/Off for a sound letting the user know that the crimper has successfully reached the target.

Require Measurement After 1st Crimp:

On/Off setting for measurement popup on the initial crimp. Continental recommends that users ALWAYS measure the initial hydraulic crimp to ensure that the crimp target is being reached (within tolerance). Turning this setting on always causes the crimper to trigger the measurement popup on the initial crimp.

Connect Bluetooth Calipers:

Configuration and support to setup Bluetooth connected calipers.

Check for Update to CrimpIQ™ Controller:

Trigger the CrimpIQ™ controller to connect to CrimpCloud® and check for application updates. If found, the controller will download and install the latest version of the application.

Note: Internet connection is required.

Check for Update to MyCrimp®:

Trigger the CrimpIQ™ controller to connect to CrimpCloud® and check for MyCrimp® application updates. If found, the controller will download and install the latest version of the MyCrimp® application.

Note: Internet connection is required.

Force CrimpCloud® Operation Sync:

Trigger the CrimpIQ™ controller to upload all operational data to CrimpCloud®.

Note: In general, Administrators should not need to manually sync data. The controller will automatically sync data to CrimpCloud® when appropriate.

Product Information - Email Terms of Service:

Provides a way for the Administrator to view the Terms of Service and if required, email them to the main contact for this machine.

View Source Attribution:

Provides information on open source software incorporated into the CrimpIQ™ controller.

Support

The application provides the user with a Technical Support system. This system allows the user to create a support ticket from within the app. The support ticket and machine status information are automatically uploaded to the Continental support staff.

Note: The system must be connected to the Internet for this function to work.

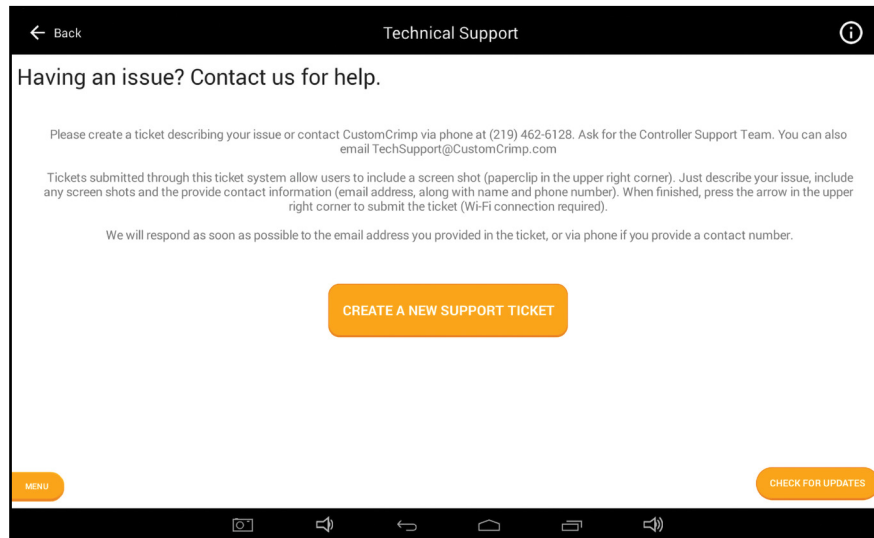

The user should create a ticket to get support:

Create a Ticket: This option allows the user to enter text to describe their issue. They can attach an image (using the camera button on the bottom menu bar to capture the screen where the error is encountered). Once submitted, this information is sent to CMS technical support staff for review and resolution.

Note: The machine must have Internet access to use this function.

Create a Ticket

To create a ticket, follow these steps:

- 1) **Enter your email address:** It is very important that this is entered correctly to ensure the support team can quickly respond directly to the person having the issue.
- 2) **Describe your problem:** Enter a detailed description of the issue you are encountering so that the support team can quickly provide support.
- 3) **Attach an image:** The CrimpIQ™ controller allows users to capture an image of any screen (using the camera button in the bottom row of icons). Images can be attached by pressing the paperclip icon in the upper right corner of the screen.
 
- 4) **Add images and text:** You can attach multiple images to the ticket and add text to explain your issue.
- 5) **Complete the process:** To complete the process and send the support ticket, press the arrow icon in the upper right section of the screen.

What Happens Next?

Once you submit the ticket, the information you entered (along with machine status and diagnostics) are sent to the Tech Support team. The team will review your ticket along with the diagnostic information and respond back to the email address provided.

The system will also send you a copy with a link to allow users to follow up on status or with additional information.

Conti Fluid Solutions

This option provides users with access to the Conti Fluid Solutions distributor site which includes tools, literature and services.

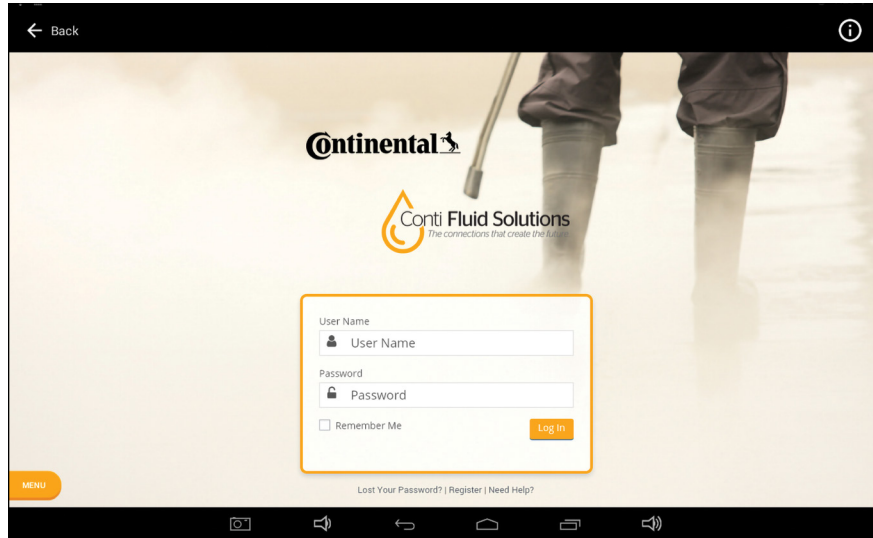

Training Manuals

The controller provides access to a number of different training manuals.

Date	Title	Description
3/22/18	Hose Assembly Manuals & Videos	Additional resources from Conti Fluid Solutions on hose assembly.
3/22/18	Getting Started Guide	New to the crimper? Here are some recommended first steps.
3/22/18	Hardware Product Manual	All the hardware details for your crimper.
3/22/18	Software Product Manual	Additional details on the software on your crimper.
3/22/18	CrimplQ Controller Setup	A guide on how to set up your crimper.
3/22/18	Hydraulic Quick Start Guide	A guide for getting started with hydraulic crimping.
3/22/18	Industrial Quick Start Guide	A guide for getting started with industrial crimping.
3/22/18	What's New in 1.2.0.0	Notes on what is new in our most recent release.

The page lists a number of support resources available to machine users. These files are downloaded as requested from the Internet (Internet connection required).

Machine Information

The Machine Information screen provides operations and administrators with access to a range of operational and machine information.

Other Topics

Integrated Caliper Measurements

The CrimplIQ™ controller supports direct integration of measurements (Crimp Diameter). This integration saves time and reduces the chance that measurements are incorrectly entered.

Configuring CrimplIQ™ Calipers (Bluetooth)

The CrimplIQ™ controller supports Bluetooth calipers to input crimp diameter measurements. Setting up bluetooth calipers:

Note: Bluetooth Calipers are included with the Continental PC200i Crimper, and should already be setup and paired with the CrimplIQ™ Controller. But if you have any issues, follow the "Connecting Bluetooth Calipers" guide on page 50 in order to set up the accessory.

- Insert the Bluetooth dongle into the top of the calipers after removing the connection cover. The "SMART" label should be facing toward the display screen.
- Tap the Bluetooth cell to see the list of Bluetooth devices, toggle to turn Bluetooth ON.
- Tap the toggle in the Bluetooth cell to turn Bluetooth ON.
- Hold the button on the Bluetooth module until the blue light starts blinking.
- The calipers should appear in the list of Bluetooth devices as "Bluetooth Keyboard" in the list of AVAILABLE DEVICES.
- Select "Bluetooth Keyboard" from the list of devices to pair. If you don't see this, turn Bluetooth off and then on.
- The "Bluetooth Keyboard" should say Pairing while it is pairing with the tablet and moved to list of PAIRED DEVICES once it is paired. The iGaging® dongle will also beep when pairing is complete.
- Select the appropriate units (in./mm).
- Make sure the units match the default units in the crimper settings menu (Main Menu → Crimper Settings → Select Preferred Unit of Measurement).
- When saving measurements from the calipers to the tablet there is a slight delay. This is due to the power saving mode of the iGaging® dongle. Please give the transfer a few seconds to complete.



Configuring CrimplIQ™ Calipers (USB)

The CrimplIQ™ controller supports USB calipers to input crimp diameter measures.

Setting Up USB Calipers

- Insert the USB cable into the top of the calipers after removing the connection cover. The "DATA" label should be facing toward the display screen.
- Plug the other end of the cable (standard USB Connection), into the USB connection on the front of the controller box.
- Turn on the calipers.
- Select the appropriate units (in./mm).
- Make sure the units match the default units in the crimper settings menu (Main Menu → Crimper Settings → Select Preferred Unit of Measurement).

Using CrimpIQ™ Calipers

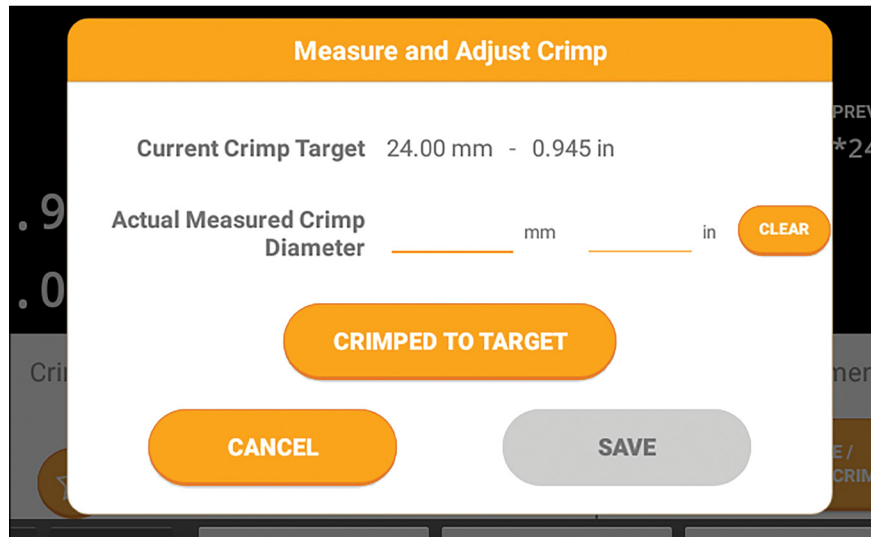

Once the calipers are connected to the controller, they can be used to enter measurements within the CrimpIQ™ controller screens.

- The calipers are now ready to use. Whenever a measurement is required (Measure/Adjust Crimp in Crimper Operations screen), the caliper's measurement can be directly entered into the text box. Simply place the cursor in the correct field and press the DATA button on the calipers. Whatever value is displayed on the caliper display will automatically be transferred into the controller.
- If calipers are connected to the controller, number entry keypads do not always appear. Simply press in the data entry field and a keypad will appear. For example, if changing users with the USB calipers connected, no keypad will appear to allow the user to enter a pin. Simply press once in the entry field and a keypad will pop up.

Connecting Bluetooth Calipers

The CrimpIQ™ Controller supports the ability to integrate with Bluetooth Calipers, allowing for fast and easy wireless transfer of measured crimp diameter to the controller.



Caliper with Bluetooth Dongle



Caliper with Wireless Bluetooth

Initial Setup: Caliper with Bluetooth Dongle

Step 1: Verify that the batteries are installed into the calipers and into the Bluetooth dongle.

Note:

- To replace batteries when needed, use a SR44SW 1.55V battery for the calipers, and CR2032 3V battery for the Bluetooth dongle.

Step 2: If necessary, remove the standard port cover from the top of the calipers above the Mitutoyo logo with a paperclip. Insert dongle into port facing same direction as caliper screen.

Note:

- There may be a cover installed over caliper accessory port. Remove with a paper clip. Then, insert the Bluetooth Accessory into the calipers, with the button facing toward the calipers screen and measurement panel.

Caliper with Wireless Bluetooth

Step 1: Use the small flat screw driver supplied, to open the battery compartment and install the battery then insert it into the calipers.

Note:

- To replace battery when needed, use a CR2032 3V battery for the wireless bluetooth calipers.

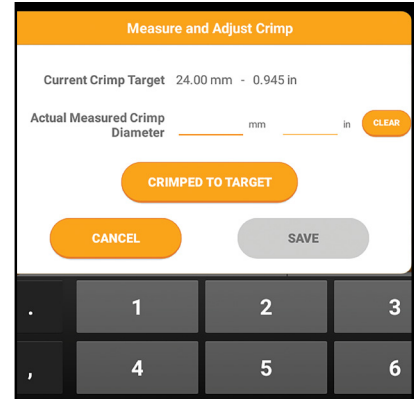

Caliper with Bluetooth Dongle

Step 3: With the caliper fully closed, hold the origin button for 2 seconds. After this is complete, the caliper screen should show 0.00 inches/millimeters when at the zero position.

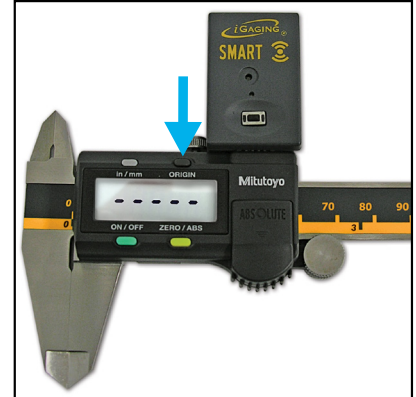

Caliper with Wireless Bluetooth

Step 3: With the caliper fully closed, the caliper screen should show 0.00 inches/millimeters when at the zero position. If needed hold the origin button for 2 seconds to reset at the zero position.

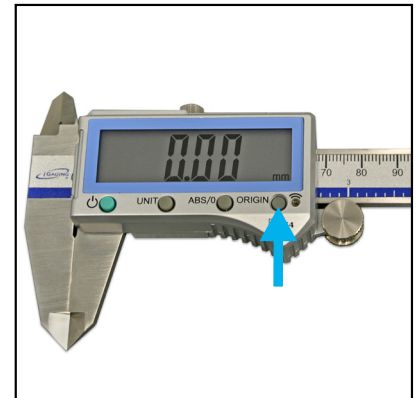

Step 4: **Access the device's Bluetooth Settings:** Swipe down from the upper right of the device screen, to reveal an options panel. Tap the Bluetooth button to open the Bluetooth management page.

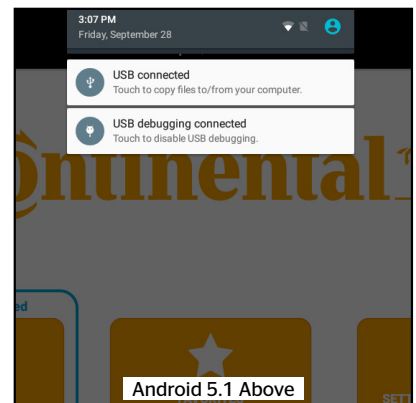

Step 5: Tap gray area in pull down menu and tap the Gear icon to show full settings menu.

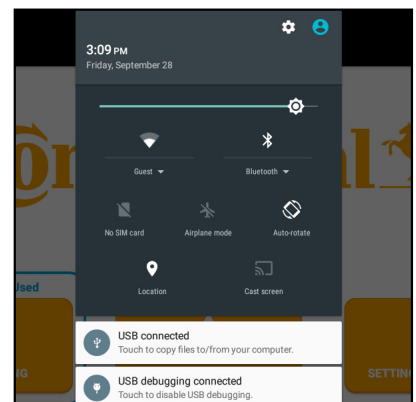

Step 6: Tap the Bluetooth Button and launch the Bluetooth Menu.

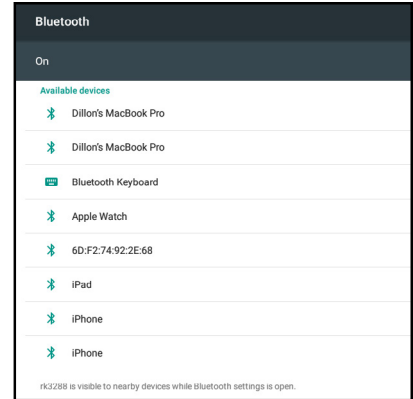

Caliper with Bluetooth Dongle

Step 7: Hold Bluetooth Accessory button, until the blue light blinks.

Note:

- Firmly press and hold on the Bluetooth accessory's click button for approximately 5 seconds, or until the blue light begins to flash.



Caliper with Wireless Bluetooth

Step 7: Hold Bluetooth Accessory button, until the blue light blinks.

Note:

- Firmly press and hold on the Bluetooth accessory's click button for approximately 5 seconds, or until the blue light begins to flash.



Step 8: Find the Bluetooth Accessory in the list of all available devices: First, make sure that the Bluetooth feature switch is in the On position. When Bluetooth is enabled and the blue light on the adaptor is flashing, the device should appear on the list with the name "Bluetooth Keyboard", and you should see other devices available as well, for nearby phones or computers. It is possible that the device will appear with no name, or a name such as

OF : 5E : 12 : 9A : B4

, or any other group of letters and numbers. If a series of letters appears, you should still see the gray keyboard icon to the left of the device name. Tap on this item in the list while the blue light is still flashing on the calipers to begin the syncing process.

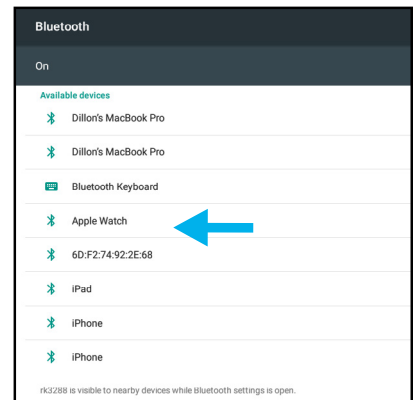

Step 9: Test Using the Caliper: The calipers will still work in text entry fields in the app where a diameter needs to be entered. Just make your measurement and tap once on the silver entry button on the Bluetooth Accessory.

Note:

- The accessory automatically powers itself off when not in use (you still need to power the caliper screen off between each use), and will turn back on after pressing the button. With this behavior, it may take a second for the calipers to register a measurement when performing a first measurement of the day.

Troubleshooting: Number Pad Not Showing

If you find testing the calipers that the number pad isn't displaying on screen to manually enter values or login as different Users it is because the **Show Input Method** setting is off. This should be turned ON during setup but if it is ever missed it can be fixed manually.

Solution:

Step 1: First go to the Android Settings screen outlined in Step 1.

Step 2: Then scroll down, and in the **Personal** section, tap on **Language & Input**

Step 3: Once in Language & Input, tap **Current Keyboard** in the Keyboards & input methods section.

Step 4: A dialog will appear. Tap **Hardware: Show input method** to turn it's toggle to the ON position. The dialog should close automatically.

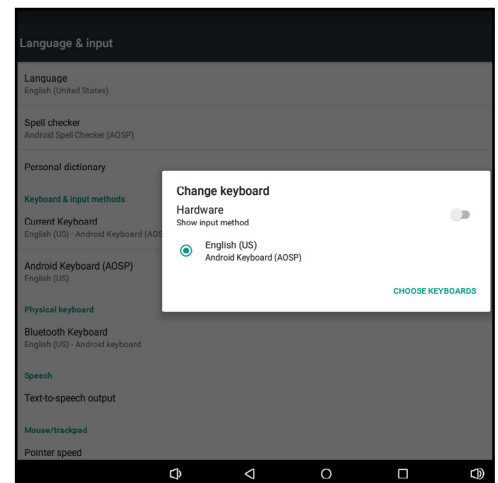
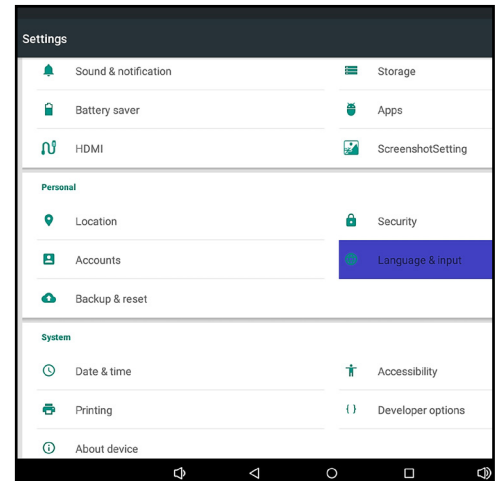

Additional Notes about the Bluetooth Caliper Accessory:

- If power is lost to the Bluetooth Accessory (for example, if the battery dies) replace the battery and hold the send button on the module until it beeps and the blue light blinks. This should reconnect the module to the tablet. If the device does not connect automatically, follow the steps above to reconnect the accessory.

PC1200i Die Part Identification

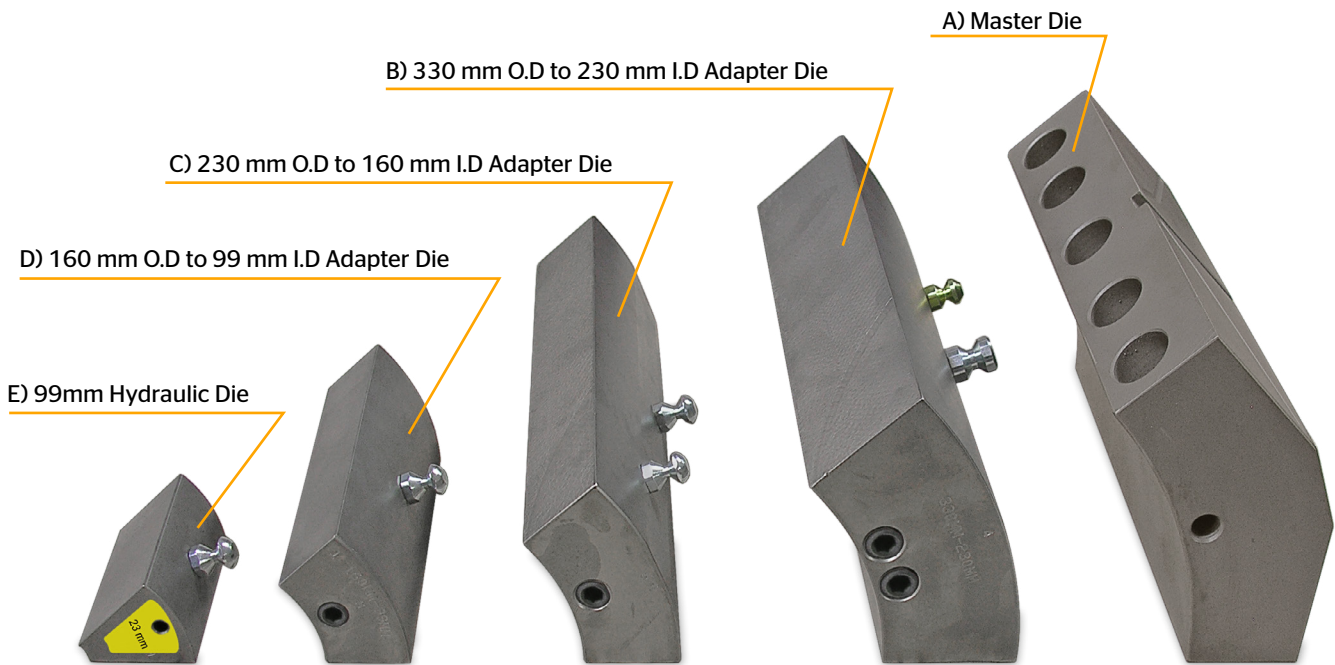
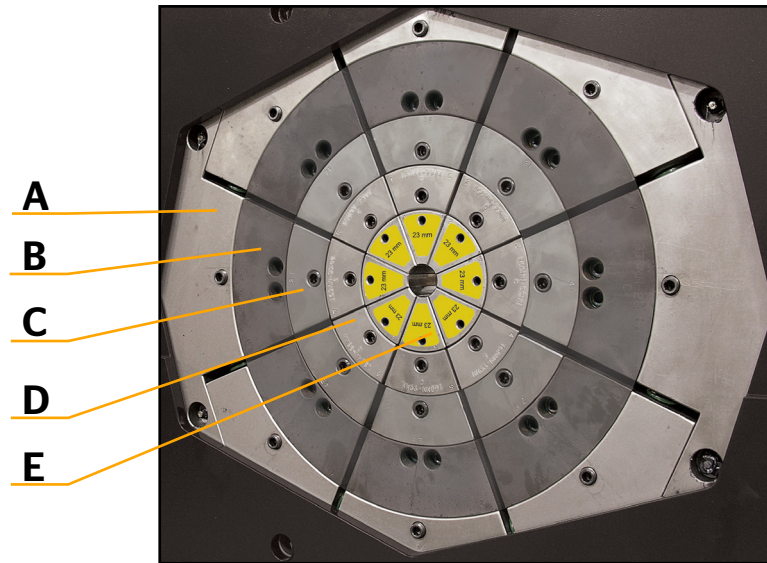

PC1200i Die Installation and Management

PC1200i Adapter Die Installation

Notes:

- The 330 mm O.D to 230 mm I.D, 230 mm O.D to 160 mm I.D, and 160 mm O.D to 99 mm I.D are available with the crimper. Adapter Dies are held in place by the die locking pins (as shown in photo #1).
- The I.D of the adapter dies must match the O.D of the corresponding hydraulic die set or accurate crimps can not be made.

To begin, first bring the master dies to the fully opened position and install the **330 mm O.D to 230 mm I.D adapter die**, each finger individually (as shown in photo #2).

Notes:

- The die size stamped on the face of the adapter die should face toward the operator.
- Use the T-Handle Wrench provided with the crimper to tighten the master die locking stud to secure the adapter die finger. Repeat the same process for the remaining 7 adapter die fingers.

Next, install the **230 mm O.D to 160 mm I.D adapter die**, each finger individually (as shown in photo #3).

Notes:

- The die size stamped on the face of the adapter die should face toward the operator.
- Make sure to tighten the (2) die locking studs (as shown in photo #3).
- Repeat the same process for the remaining 7 adapter die fingers.

Next, install the **160 mm O.D to 99 mm I.D adapter die**, each finger individually (as shown in photo #4),

Notes:

- The die size stamped on the face of the adapter die should face toward the operator.
- Tighten the die locking stud (as shown in photo #4).
- Repeat the same process for the remaining 7 adapter die fingers.
- Verify that all the adapter dies are secured.

Crimping with (330 OB) Industrial Die Series

Note:

- To crimp with industrial dies all the adapter dies need to be removed. Proceed to install the industrial dies.



Photo #1



Photo #2

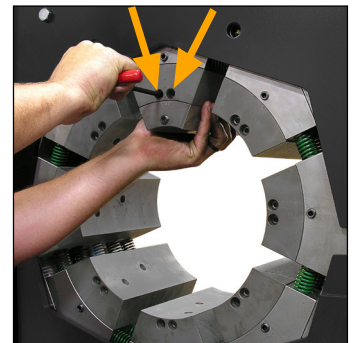

Photo #3

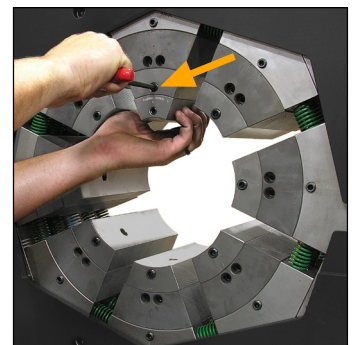

Photo #4



PC1200i Hydraulic Die Installation

Notes:

- With the adapter dies installed:
 - (A) 330 mm O.D to 230 mm I.D
 - (B) 230 mm O.D to 160 mm I.D
 - (C) 160 mm O.D to 99 mm I.D

(as shown in photo #1) use the Quick Change Tool to install the 99P hydraulic die set.

Note:

- *The I.D of the adapter die must match the O.D of the corresponding hydraulic die or accurate crimps can not be made.*

To begin, first bring the crimper head to the fully opened position and install the 99P hydraulic die set with the quick change tool (as shown in photo #2).

Note:

- *The die size stamped on the face of the 99P hydraulic die set should face toward the operator.*

Align the studs of the 99P hydraulic die set with the holes in the adapter die (as shown in photo #2) and with the crimper in manual mode SLOWLY close the crimper head on the 99P hydraulic die set.

Next, bring the crimper head to the fully closed position (as shown in photo #3).

Remove the quick change tool (as shown in photo #4).

Notes:

- *The 99P hydraulic die set may also be inserted manually (each finger individually) with the crimper head in the fully open position.*
- *For 99P hydraulic die removal, place the crimper in manual mode and bring the crimper head to the fully closed position. Insert the quick change tool and open the crimper head releasing the 99P hydraulic die set from their spring retention holes.*

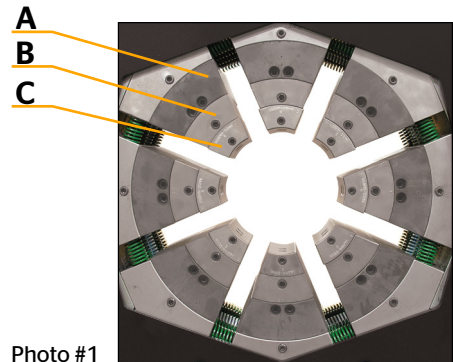

Photo #1

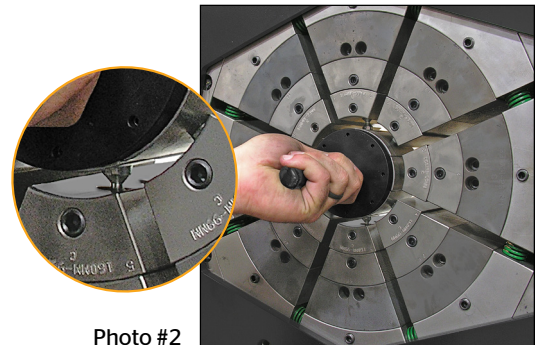

Photo #2

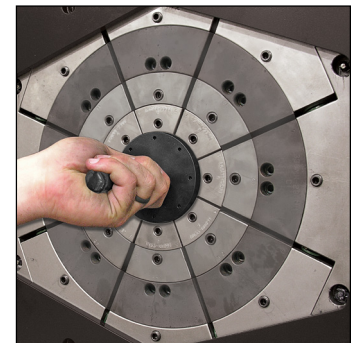

Photo #3

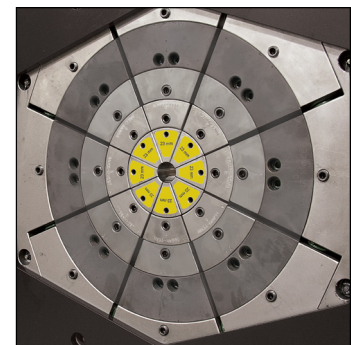

Photo #4

PC1200i Lubrication Procedure

Notes:

- Use the mini grease gun with flush fitting adapter with grease (supplied with the crimper) as shown in photo #1 or a high-pressure moly grade grease can be used as well.
- Failure to lubricate the crimper can cause premature failure, loss of accuracy and may result in damage to the crimper.
- Lubricate the crimping head after each 400 crimping cycles or at the start of each shift if the crimper is used in a production setting.

To begin, first bring the master dies to the fully closed position, and lubricate the master dies through the (4) lubrication fittings in the protective plates (as shown in photo #2).

With the master dies in the fully closed position, lubricate the (4) lubrication fittings visible through the master dies lubrication fittings (as shown in photo #3).

With the master dies still in the fully closed position, lubricate the (2) lubrication fittings visible through the side guide plates on each side (as shown in the photo #4).

Notes:

- Parking the crimper in the fully open position when it is not in use will prolong the life of the master die springs.
- Check the wear surfaces for grease. If the surfaces show any signs of wear, apply more grease. If you touch the wear surfaces, you should see a thin layer of grease on your finger.



Photo #1

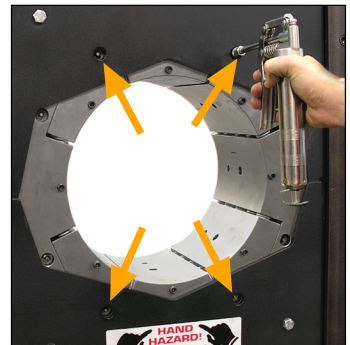

Photo #2

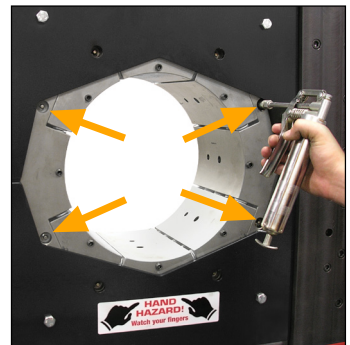
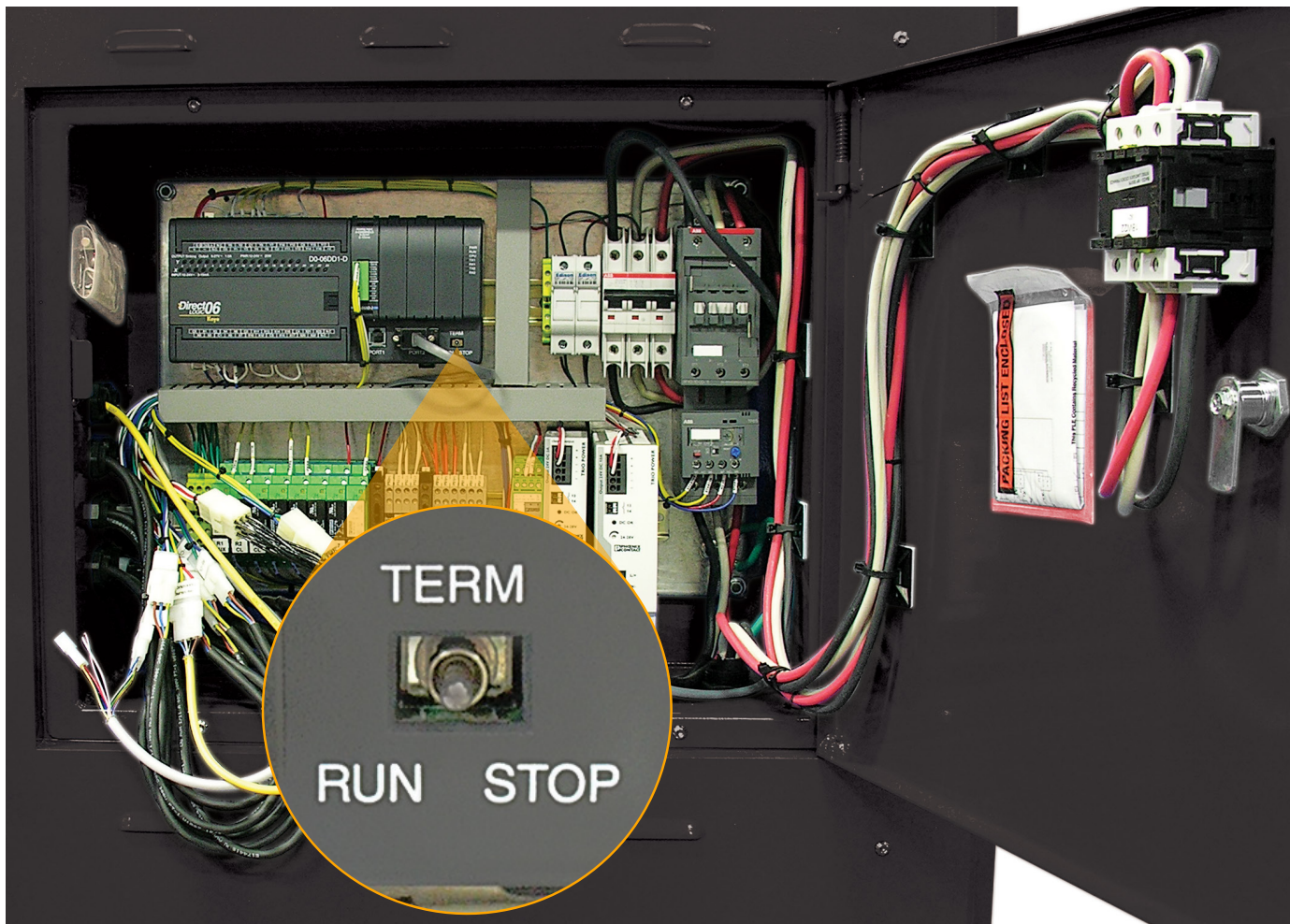

Photo #3



Photo #4

PC1200i PLC Reset Procedure



The PLC (Programmable Logic Controller) requires a relatively constant source of electrical power. Power surges, outages or drops in power can cause the PLC to lose its settings. This may result in missing or misplaced information on the controller screen.

Resetting the PLC to its original settings

- Open the electrical enclosure.
- Power up the crimper from the main power switch. The crimper must be powered on during the PLC reset procedure.
- Move the three position toggle switch on front of the PLC right to the STOP position and then left to the RUN position.
- Return the toggle switch to the center TERM position.
- Cycle the main power off and back on.
- The PLC and the crimper should now operate normally.
- Close the electrical enclosure.

1200i Troubleshooting

PROBLEM: THE CRIMPER WILL NOT RUN AT ALL:

- Check the E-Stop switch to be certain that it is not depressed. A slight twist is required to release switch after it has been depressed.
- The PLC (Programmable Logic Control) must be reset. See instructions on the previous page.

PROBLEM: THE CRIMPER RUNS BUT IS SLOW OR NON-FUNCTIONAL:

- Check electrical circuit to be certain that it matches the crimper's requirements shown on the voltage tag attached to the crimper cord. Many performance problems are the result of low voltage or inadequate electrical service.
- Check motor rotation and be certain that the motor rotates in the direction of the arrow on the motor housing.

Note:

- *For three phase units rotation can be reversed by switching any two wires in the plug.*

PROBLEM: THE CRIMPER WILL CLOSE ON THE FITTING BUT DOES NOT DEVELOP POWER TO COMPLETE THE CRIMP:

- Position the master dies to the fully opened position and check the hydraulic oil level in the sight glass window on the front of the reservoir. Be sure that the oil level is in the middle of the sight glass window.

Note:

- *Use ISO grade 46 hydraulic oil.*

PROBLEM: THE CRIMPER WILL NOT OPEN TO RETRACT POSITION IN AUTO MODE:

- The retract position must be at least 3 mm larger than the final crimp diameter.

If problems persist contact Customer Service for additional troubleshooting assistance.

1200i Warranty

Should you experience difficulty with any product or part and require technical support, first contact Customer Service at 1-800-235-4625. This Continental branded crimper is manufactured especially for ContiTech and is covered by the manufacturer under the below warranty.

Custom Crimp® “No Nonsense” Warranty

All Custom Crimp® products are warranted to be free of defects in workmanship and materials for one year from the date of invoice. This warranty ends when the product becomes unusable for reasons other than defects in workmanship or material.

If any product or part manufactured by Custom Crimp® is found to be defective by Custom Crimp®, at its option Custom Crimp® will either repair or replace the defective part or product and return via ground transportation, freight prepaid.

This warranty does not cover any product or part which is worn out, abused, altered, used for a purpose other than for which it was intended or used in a manner which was inconsistent with any instructions regarding its use.

Electric motors are separately warranted by their manufacturer under the conditions stated in their separate warranty.

Industrial Fluid Solutions

Market segment
Hydraulic Hose

Contact
ContiTech
703 S. Cleveland Massillon Road
Fairlawn, OH 44333-3023 U.S.A.
1-800-235-4632
www.contitech.us

Your local contact
www.contitech.de/contactlocator

Canada
1-888-275-4397

Mexico
1-800-439-7373

Continental. Smart Solutions Beyond Rubber

The ContiTech division of the Continental Corporation is one of the world's leading industry specialists. As a technology partner, our name is synonymous with expertise in development and materials for components made of natural rubber and plastics and also in combination with other materials such as metal, fabrics or silicone. By integrating electronic components, we are also generating solutions for the future.

Beyond products, systems and services, we also provide holistic solutions and have a formative influence on the industrial infrastructure. We see digitalization and current trends as an opportunity to work with our customers to add sustainable value – for both sides and for good.

Rev: 10/07/2020